

53

APR 2 1968

SERVICE
MANUAL 2275

marantz

model 2275

Stereophonic Receiver

TABLE OF CONTENTS

SECTION	PAGE
Introduction	1
Service Notes	1
AM Tuner	1
FM Tuner	2
Phono and Tone Amplifiers	5
Power Amplifier	5
Power Protection Circuit	6
Speaker Protector Relay Circuit	6
Suggestions for Troubleshooting the Power Amplifier	6
Test Equipment Required for Servicing	7
AM Alignment Procedures	7
FM Alignment Procedures	8
Stereo Separation Alignment	8
Muting Circuit Alignment	8
FM Dolby Level Adjustment	9
Audio Adjustments	9
Parts List	20~32
Technical Specifications	33~34
Servicing Informations for European Model	35~37,39

LIST OF ILLUSTRATIONS

FIGURE	PAGE
1. Block Diagram of the HA1156	4
2. Dial Stringing	10
3. Front Panel Adjustments and Component Locations	11
4. Main Chassis Component Locations (Top View)	11
5. Rear Panel Jacks and Component Locations	12
6. Main Chassis Component Locations (Bottom View)	12
7. FM Front End Assembly P100 Component Locations	13
8. AM Tuner Assembly P150 Component Locations	13
9. FM IF Amplifier Assembly P200 Component Locations	13
10. MPX Stereo Decoding Amplifier Assembly P300 Component Locations	14
11. Dolby FM Level Amplifier Assembly PC01 Component Locations	14
12. Phono Amplifier Assembly P400 Component Locations	14
13. Power Amplifier Assembly P700 Component Locations	15
14. Power Supply and Protection Relay Circuit Assembly P800 Component Locations	15
15. Pre and Tone Amplifier Assembly PE01 Component Locations	16
16. Dolby FM, Mono L, R, Multipath and Tape Monitor Switches Assembly PS01 Component Locations	16
17. Muting, Speaker, Loudness, Power, Hi and Low Filter Switches PT01 Component Locations	16
18. Function Lamps Assembly PY01 Component Locations	17
19. Muting Level and Antenna Attenuator Assembly PU01 Component Locations	17
20. Dial Scale Illuminator Assembly PZ01 Component Locations	17
21. Exploded Mechanical Diagram	18~19

22. Fuse Assembly PR01 Component Locations for European Model	35
23. Rear Panel Jacks and Component Locations for European Model	36
24. Main Chassis Component Locations (Bottom View) for European Model	36
25. Voltage Conversion Chart for European Model	37
26. Schematic Diagram for U.S.A. Model	38
27. Schematic Diagram for European Model	39

TABLE	PAGE
1. Test Equipment Required for Servicing	7

INTRODUCTION

This service manual was prepared for use by Authorized Warranty Stations and contains service information for the Marantz Model 2275 Stereophonic Receiver.

Servicing information and voltage data included in this manual are intended for use by knowledgeable and experienced personnel only. All instructions should be read carefully. No attempt should be made to proceed without a good understanding of the operation of the receiver.

The parts list furnishes information by which replacement parts may be ordered from the Marantz Company. A simple description is included for parts which can usually be obtained through local suppliers.

1. SERVICE NOTES

As can be seen from the circuit diagram, the chassis of the Model 2275 consists of the following units. Each unit mounted on a printed circuit board is described within the square enclosed by a bold dotted line on the circuit diagram.

- 1. FM Front End Mounted on P.W. Board P100
- 2. FM IF Amplifier Mounted on P.W. Board P200
- 3. AM Tuner Unit Mounted on P.W. Board P150
- 4. MPX Stereo Decoding Amplifier Mounted on P.W. Board P300
- 5. Phono Amplifier Mounted on P.W. Board P400
- 6. Power Amplifier Mounted on P.W. Board P700
- 7. Power Supply and Protection Relay Circuit Mounted on P.W. Board P800
- 8. Pre and Tone Amplifier Mounted on P.W. Board PE01
- 9. Dolby FM Level Amplifier Mounted on P.W. Board PC01
- 10. Muting, Speaker, Loudness, Power, Hi and Low
Filter Switches Mounted on P.W. Board PT01
- 11. Dolby FM, Mono L, R, Multipath, and Tape
Monitor Switches Mounted on P.W. Board PS01
- 12. Function Lamps Mounted on P.W. Board PY01
- 13. Dial Lamps Mounted on P.W. Board PZ01
- 14. Muting Level and Antenna Attenuator Mounted on P.W. Board PU01

2. AM TUNER

The AM Tuner section in the 2275 consists of one IC, including an RF amplifier, local oscillator, mixer, IF amplifier, and detector, and three transistors, one of which comprises a signal strength indication amplifier and the other two comprise a detected audio signal amplifier.

All components except the tuning capacitor and ferrite bar antenna are mounted on the printed circuit board P150.

The AM signal induced in the ferrite bar antenna is fed to the RF amplifier input (Pin 12) and amplified to the level required for overcoming conversion noise, thus giving good S/N performance. The tuned circuit inserted in each of the output and input circuits of the RF amplifier assures very high image and spurious rejection performance.

The amplified and selected AM signal is then applied to the Mixer input. The local oscillator voltage is injected to the other Mixer input (Pin 16) through a capacitor C157. Then, both AM signal and local oscillator output voltage are mixed and converted into the 455kHz intermediate frequency. The resulting IF signal is applied to the IF transformer L153 consisting of one ceramic filter and two tuned circuits.

The output of L153 is fed to the IF amplifier input (Pin 9) through a coupling capacitor C162 and amplified to a sufficient level to drive the detector. The detected audio signal derived from pin 7 is filtered and amplified, and the final audio output is obtained from the collector of H153 and applied to the TAPE MONITOR OUT jacks through the function switch S001.

The DC component of the detected IF signal is used as an AGC voltage to control the emitter

current of the RF amplifier through the AGC amplifier incorporated in the IC. A part of the DC component is also fed from J157 to the signal strength indication amplifier H154. The output appearing at the collector of H154 is level adjusted by R178, indicated on the signal strength meter M002.

2.1 Suggestions for AM Tuner trouble shooting

Check for a broken AM bar antenna. Next, attempt to tune stations by rotating the fly-wheel tuning knob slowly and observe the AM signal strength meter for deflection. If the signal strength meter gives a deflection at several frequencies received, a probable failure exists after the AM detector stage. Next, connect an oscilloscope to J161 and check for audio signals with the tuning meter deflected. If the signal strength meter does not deflect, check the local oscillator circuit. Normal local oscillator output voltage at the hot end of the oscillator tuning capacitor is about 1.5 to 3 volts, varying with the tuning capacitor position. When measuring the local oscillator output voltage use an RF VTVM, no common circuit tester will give a correct indication, due to loading. If the local oscillator output voltage is normal, check all voltage distribution in the AM circuits by using a DC VTVM and compare the measured values with those given in the schematic diagram.

3. FM TUNER

The FM Tuner section in the Model 2275 is divided into four functional blocks: FM Front End, IF Amplifier & Detector, Muting Control and Multiplex Stereo Decoding Circuit.

An FM signal from an FM antenna is fed to antenna coil L101 from the balun coil. The signal is then applied to the FET RF amplifier which in turn feeds its output to the FET Mixer H102 through a triple tuned, high selectivity circuit. The FET Mixer converts its input signal into a 10.7MHz intermediate frequency and amplifies it at the same time. H103 is the local oscillator, the output of which is injected into the source of the FET Mixer. The injection voltage is approximately 700mV. The 10.7MHz front end output is fed to the IF amplifier from J105.

The IF amplifier unit consists of eight IF amplifier stages, one AGC amplifier stage and an audio buffer amplifier stage. Eight ceramic filters are also used to obtain high selectivity, and four symmetrical diode limiter stages are also employed for best limiting characteristics, improved capture ratio and good AM suppression.

A part of the FM Front End output is fed to and rectified by the AGC amplifier H209, and the rectified output is fed back to the gate of the FET RF amplifier from J208 to decrease the gain with increased signal strength.

The signal required for multipath indication is obtained from five IF amplifier stages through coupling capacitors C211, C214, C223, C252 and C228 respectively and is rectified by four full wave rectifier diodes H221 through H228. These AM components of the FM signal are mixed and amplified by transistors HS01 and HS02 and the output is again rectified to obtain DC current required for actuating the signal strength meters, which is used for multipath indication as well.

The IF signal is fed to the Detector Amplifier H208. The detected audio output is fed to the buffer amplifier H210 and its output is fed to: (a) the noise amplifier H310 through resistor R378 and capacitor C333, (b) the QUADRADIAL OUTPUT Jack on the rear panel through resistor R379, and (c) the MPX stereo decoding IC (H321) through R301 and H301.

The DC current developed at the third winding of the discriminator transformer is directly connected to the FM center tuning meter.

3.1 Audio Muting and Stereo mode auto-selecting circuit

100% solid state muting is incorporated in the Model 2275. Three inputs control the muting function. The first is related to signal strength, the second to the noise level at the detector, and the third is derived from the DC component of the detector output. These inputs are properly matrixed and gated to provide muting free from noise and transients.

The first input of DC voltage obtained by rectifying a part of the IF signal from H205 and H206 is fed to the base of H308 and turns it on. This level is predetermined by the muting threshold level control. When H308 is turned on, H309 is turned off, allowing the emitter-collector resistance to be increased and the collector voltage to be raised to about 9V. The raised collector voltage increases the gate bias voltage and turns on switching FET H301, decreasing the source-drain resistance to near zero and allowing the audio signal applied at the source to flow to the decoding IC, pin ②.

When the input signal is lower than the predetermined level, the DC output obtained is small and can not turn on H308, thus H308 remains off. This turns H309 on, decreasing its collector voltage and turning H301 off. Thus, no audio signals can pass through FET H301. This is the fundamental principle of the muting operation but for more elaborate muting, the second and third inputs are necessary.

The second input is used to protect the muting operation and MPX stereo lamps from misoperation due to undesirable noise. High frequency noise included in the detected audio signal is separated by a small capacitor, C333, and amplified by noise amplifier transistor H310. Its output is rectified by the two diodes. The rectified DC output is proportional to the noise component in the audio signal.

When there is excessive noise in the audio signal such as obtained with a station incorrectly tuned, the rectified DC output turns transistor H311 on, decreasing the emitter-collector resistance to zero. This lowers H309 collector voltage to 0. Therefore, H301 is turned off and any audio signal having excessive high frequency noise can not go through the FET's source-drain path. Transistor H317, also, turns off when transistor H309 or H311 turns on. This turns on transistor H303 connected to pin ⑧ on the MPX decoding IC. Pin ⑧ is therefore grounded and puts the IC in the monaural mode of operation. This prevents stereo misoperation due to undesirable noise when the FM tuning is incorrect.

The third input is obtained from the FM discriminator circuit. The DC output, so called "S" curve, is applied to the gate of H312 through resistor R281 and voltage divider network (R361 & R362). The DC output is zero with a station correctly tuned in, but will vary from a negative to a positive value, or vice versa, when the tuning point is deviated toward either a higher or lower frequency from correct tuning.

When the DC output is increased to a greater positive level than predetermined, the increased source potential of H312 turns transistor H315 on. (This means the collector of H309 is grounded, H301 turns off, H317 turns off, and H303 turns on. This grounds pin ⑧ of the MPX stereo decoding IC, therefore the decoder is set in the monaural mode of operation and the stereo indicator lamp turns off. When the DC output is increased to a greater negative level than predetermined, the decreased source potential turns off H313 which turns H314 on. (This means the collector of H309 is grounded). The subsequent changes are exactly the same as that just described above.

Thus, when the tuning is shifted or deviated to certain frequencies at which undesirably noisy side responses are produced, both muting and monaural/stereo switching transistors H303 are operated automatically to provide muting.

With the station correctly tuned, the bias current of FET H312 is adjusted so that both transistor H314 and H315 are not turned on, resulting in no effect on transistor H309.

3.2 MPX Stereo Decoding Circuit

The stereo composite signal from the buffer amplifier undergoes a phase compensation by R301 and C301, is fed through the muting FET H301 to the input terminal pin ② of the MPX stereo decoding IC H321. This IC uses PLL (Phase Locked Loop) technology and decodes the left and right stereo signals, which become available at pins ④ and ⑤, respectively. These decoded left and right stereo audio signals are introduced through a low pass filter consisting of L301 to L304 and C311 to C320 for elimination of undesirable residual switching signals and then through a de-emphasis network consisting of R325, R326, C321 and C322 to a npn-pnp direct

coupled audio amplifier, where the signals are amplified and fed to output terminals J311 and J313. From these terminals, the audio signals are fed to the TAPE MONITOR OUT jacks through the function switch. Figure 1 presents an internal block diagram showing the functions of the PLL MPX stereo decoding IC HA1156. The input stereo composite signal, amplified by the audio amplifier, is delivered to the phase detectors PD-1 and PD-2. A part of the stereo composite signal is also delivered to the stereo decoder section. The VCO (Voltage Control Oscillator) produces a free run oscillation of approximately 76kHz with the time constant determined by capacitor C305 and resistors R311 and R312 connected on the outside to pin ⑭. The VCO output has its frequency divided down to 19kHz through the two frequency divider stages (DIV-1, DIV-2), and is returned to the phase detector PD-1, which contains two input terminals designed to produce an output in proportion to the product of the two input signals. The signal fed to one PD-1 input is a 19kHz square wave formed through frequency division of the 76kHz VCO output signal by the two frequency divider stages DIV-1 and DIV-2, and the 19kHz pilot signal included in the stereo composite signal, as a reference signal is fed to the other PD-1 input. Therefore, the output of PD-1 which has gone through the low pass filter, LPF-1, provides DC output voltage in proportion to the phase variance between the two inputs. This DC output voltage is amplified by the DC amplifier, and is supplied to the 76kHz VCO as a control voltage. This means that the output frequency and phase of the VCO have been phase-locked to the input pilot signal. The 38kHz sub-carrier reproduced by the PLL, as stated above, is delivered through the stereo switch to the stereo decoder section as a switching signal, thus driving the decoder stage. One of the inputs of PD-2 is given the 19kHz resulting from the frequency division completed by DIV-1 and DIV-3, whereas the other input receives the 19kHz output contained in the composite signal, and the output is provided with a DC component in proportion to the amplitude of the pilot signal.

This DC output is furnished through LPF-2 to the trigger amplifier which drives the stereo indicator lamp and stereo switch. Therefore, insufficient supply of the pilot signal results in failure to light the stereo indicator and to turn on the stereo switch located in the path of the 38kHz switching signal, thereby avoiding a wrong stereo operation.

H303 located off pin ⑧ is a switching transistor for automatic monaural-stereo mode selection. When the intensity of an incoming signal from an FM station is weaker than a predetermined level, H303 is turned on and pin ⑧ is grounded, thereby developing a condition for monaural reception. For forced monaural operation, switching the MODE switch to "MONO", turns on H303 with the positive bias voltage applied to the base, and pin ⑧ is

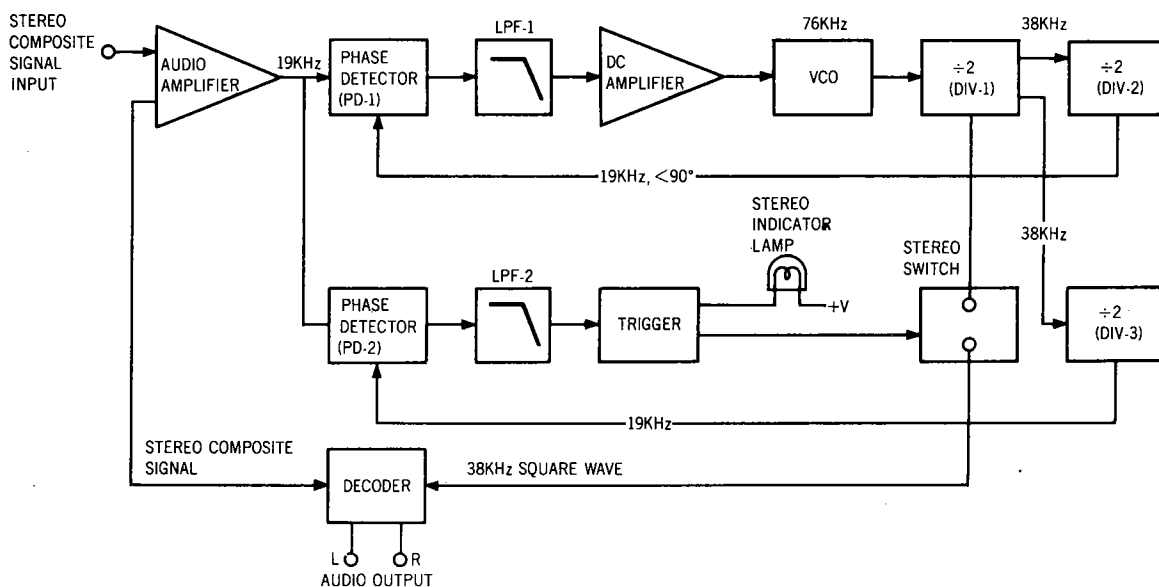

Figure 1. Block Diagram of the HA1156

grounded, thereby establishing monaural operation. Transistor H302, connected externally to pin ⑭, is intended to kill the 76kHz VCO (oscillator) which interferes with AM signals during the reception of an AM stations. When the function switch is set to "AM" position, a positive bias is applied to the base of H302, turning it on and pin ⑭ is grounded. Thus, the oscillation of the VCO is stopped, ending the interference with AM reception.

3.3 Suggestion for Troubleshooting the FM Tuner

3.3.1 Symptom: No FM Reception

Rotate the fly-wheel tuning knob slowly and observe the FM signal strength meter. If the signal strength meter deflects at several frequencies received, the tuner and IF circuits preceding the discriminator circuit are functioning. When no reading is obtained on the meter, check the FM local oscillator circuit, using an RF VTVM. The normal local oscillator voltage is approximately 500mV at the tuning capacitor, depending on the tuning capacitor position. If the local oscillator voltage is present, then check all voltage distribution in the FM Front End and IF amplifier unit comparing them with those shown in the circuit diagram. When the signal strength meter deflects but no sound is obtained, check the audio circuits using a high sensitivity oscilloscope.

3.3.2 Symptom: No Stereo Separation

First be sure the "MODE" switch is in the normal 2 CH position. Connect an FM RF signal generator with output modulated by a stereo pilot signal to the rear FM antenna terminals, and check for stereo light operation. If not turned on, check for 19kHz VCO output signal (J310), using an oscilloscope and frequency counter.

4. PHONO AND TONE AMPLIFIERS

Program source signals from the PHONO jacks on the rear panel are fed to the input circuit of the Phono Amplifier through the selector switch, and the output of the Phono Amplifier is fed to another section of the selector switch. This amplifier provides a gain of 40dB.

All signals selected by the function switch (S001-2R, 4R) are fed to the balance and volume controls through the MONO (L, R) and Hi-Blend switches.

Signals properly attenuated by the volume control are led to the tone amplifier and are subjected to tone control by the bass, mid and treble controls, and high and low cut filters.

These processed audio signals are then fed to the PRE OUT jacks on the rear panel.

5. POWER AMPLIFIER

The signal from the tone amplifier is applied to the differential amplifier (base of H701) through the coupling capacitor C701. The differential amplifier provides a high input impedance, and its collector output (H702) is connected to the base of H703 which in turn feeds its output to the following stages: H711 through the network of R720, C711 and R721, and H712 through the network of R720, C712 and R722. The outputs of H711 and H712 are fed to H713 and H714, respectively. H001 and H002 are power transistors used in a complementary configuration and mounted on heat sinks.

To maintain overall amplifier stability and linearity, degenerative feed back is utilized throughout the amplifier. This feedback is also necessary to reduce distortion to within a specified limit. The RC network of R724 and C709 conditions the feed back signal for audio signals. R723 and C708 also comprise a feedback loop provided to obtain a stable zero DC offset voltage at the speaker output terminals. R741 is a potentiometer resistor to adjust the DC offset voltage to zero.

A dynamic bias is applied to the bases of driver transistors H713 and H714. This dynamic bias circuit is comprised of H709, H710 and R742. This provides a variable base bias for the driver transistors that automatically maintains the proper base voltage with temperature change.

The temperature sensitive biasing components of the dynamic circuit are thermally coupled to the heat sink which mount the power transistors.

6. POWER PROTECTION CIRCUIT

A protection circuit for the amplifier is provided by sensing resistor networks and two switching transistors. When the output transistors are over-driven, the current increase through the power output transistors cause an increased current flow through R740. This increased voltage potential is applied to the base of H708 through resistor R736 and H705 turning H708 on. Since the emitter of H708 is connected through R727 to the base of H713, the base of H713 is by-passed to the common center point through the emitter-collector path of H708. Thus, the input signal to H713 is restricted to the value which maintains the operation of the output stage within the safe area. Resistors R730 and R729 with H717 works as a sensing network. When the center voltage (collector voltage of power transistors) is excessively increased to a positive value by certain malfunctions, the voltage applied to the base of H705 turns H708 on, thus removing the drive from H713 and the power transistor. For the other half cycle of the driving signal, the same operating principle is applied as described above, through H706 and H707.

7. SPEAKER PROTECTOR RELAY CIRCUIT

The speaker protection circuit consisting of H805, H806, H807, and associated parts protects the speaker systems against turn "ON" and "OFF" transients. This circuit is so designed that no sound is heard for the first three to five seconds after the power switch is turned on by the time constant circuit consisting of C809 and R813. This circuit also protects the speaker system against difficulties due to poor DC balance between the speaker system terminals by instantly operating the relay and cutting off the speaker system from the circuit. When a positive DC off balance voltage is developed between speaker terminals by possible defects such as defective power transistors, short-circuits, or a broken potentiometer R741 protection is instantly available. Since the base of H805 is connected to the speaker terminal, it is turned on by this offset voltage developed, turning transistors H806 and H807 off, thus cutting off the relay and disconnecting the speaker from the output circuit. When a negative offset voltage is developed, this voltage directly turns H806 and H807 off, giving the same protection as above.

The circuit also protects the speaker system from possible damage when the amplifier is over-driven by very low frequencies such as 7Hz or less.

8. SUGGESTIONS FOR TROUBLESHOOTING THE POWER AMPLIFIER

8.1 Excessive line consumption

- a. Check for shorted rectifier H005; also check C006 and C007.
- b. Check for shorted transistors H713 and H714, H001, H002, H003, and H004, and check H709. Check bias diode H710. Check L004 for shorts.

CAUTION: BECAUSE THE DRIVER AND OUTPUT STAGES ARE DIRECT COUPLED, SEVERAL COMPONENTS MAY FAIL AS A DIRECT RESULT OF A SINGLE INITIAL COMPONENT FAILURE. IF A SHORTED TRANSISTOR OR ZENER DIODE IS FOUND, OR CONTROL OR BIAS DIODE, BE SURE TO CHECK THE REMAINING DRIVER AND OUTPUT COMPONENTS FOR SHORTS OR OPEN CIRCUITS BEFORE REENERGIZING THE AMPLIFIER.

8.2 No Line Consumption or Zero Bias

- a. Check line cord, fuse, transistors H709, H001, H002, H003, and H004, and bias diode H710.
- b. Check for open rectifier H005 or open L004.

9. TEST EQUIPMENT REQUIRED FOR SERVICING

Table 1 lists the test equipment required for servicing the Model 2275 Receiver.

Item	Manufacturer and Model No.	Use
AM Signal Generator		Signal source for AM alignment.
Test Loop		Used with AM Signal generator.
FM Signal Generator	Less than 0.2% distortion	Signal source for FM alignment.
Stereo Modulator	Less than 0.2% distortion	Stereo separation alignment and trouble shooting.
Frequency Counter		MPX Oscillator adjustment (VCO).
Audio Oscillator	Weston Model CVO-100P, less than 0.02% residual distortion is required.	Sinewave and squarewave signal source.
Oscilloscope	High sensitivity with DC horizontal and vertical amplifiers.	Waveform analysis and trouble shooting, and ASO alignment.
VTVM	With AC, DC range RF type	Voltage measurements.
VTVM Circuit Tester		Trouble Shooting.
AC Wattmeter	Simpson, Model 390	Monitors primary power to Amplifier.
AC Ammeter	Commercial Grade (1-10A)	Monitors amplifier output under short circuit condition.
Line Voltmeter	Commercial Grade (0-150VAC)	Monitors potential of primary power to amplifier.
Variable Autotransformer (0-140VAC, 10 amps.)	Powerstat, Model 116B	Adjusts level of primary power to amplifier.
Shorting Plug	Use phono plug with 600 ohm across center pin and shell.	Shorts amplifier input to eliminate noise pickup.
Output Load (8 ohms, 1%, 100W)	Commercial Grade	Provides 8-ohm load for amplifier output termination.
Output Load (4 ohms, ±1%, 100W)	Commercial Grade	Provides 4-ohm load for amplifier output termination.

Table 1. Test Equipment Required for Servicing

10. AM ALIGNMENT PROCEDURES

10.1 AM IF Alignment

1. Connect a sweep generator to J153 and an alignment scope to the test point ②.
2. Rotate each core of IF transformer L153 for maximum height and flat top symmetrical response.

10.2 AM Frequency Range and Tracking Alignment

1. Set AM signal generator to 515kHz. Turn the tuning capacitor fully closed (place the tuning pointer at the low end.) and adjust the oscillator coil L152 for maximum audio output.
2. Set the signal generator to 1650kHz. Place the tuning pointer in the high frequency end and adjust the oscillator trimmer on the oscillator section of the tuning capacitor for maximum audio output.
3. Repeat Step 1 and 2 until no further adjustment is necessary.

4. Set the generator to 600kHz and tune the receiver to the same frequency and adjust a slug core of the AM ferrite rod antenna and RF coil L151 for maximum output.
5. Set the generator to 1400kHz and tune the receiver to the same frequency and adjust both trimming capacitors of the antenna and RF sections of the tuning capacitor for maximum output.
6. Repeat Step 4 and 5 until no further adjustment is necessary.

Note: During tracking alignment reduce the signal generator output as necessary to the lowest workable signal to avoid AGC action.

10.3 AM Signal Strength Meter Adjustment

Set the AM Signal generator to 1000kHz with $5\text{K}\mu\text{V}$, and adjust R178 so that the signal strength meter reads 80% of full scale deflection.

11. FM ALIGNMENT PROCEDURES

1. Connect an FM signal generator to the FM ANTENNA terminals and an oscilloscope and an audio distortion analyzer to the TAPE MONITOR OUT jacks on the rear panel.
2. Set the generator to 87.0MHz and adjust its output to about 3 to $5\mu\text{V}$. Place the tuning pointer at the low frequency end by rotating the tuning knob and adjust the core of oscillator coil L105 for maximum audio output.
3. Set the generator to 109.0MHz and provide about 3 to $5\mu\text{V}$ output. Rotate the tuning knob and place the tuning pointer at the high frequency end and adjust the trimming capacitor C106 for maximum output.
4. Repeat Steps 2 and 3 until no further adjustment is necessary.
5. Set the generator to 90MHz and tune the receiver to the same frequency. Decrease the signal generator output until the audio output level decreases with the decreasing generator output. Adjust the antenna coil L101, RF coils L102, L103, and L104, and IF transformer L106 for minimum audio distortion.
6. Set the generator to 106MHz and tune the receiver to the same frequency. Adjust the trimming capacitors of antenna and RF tuning circuits for minimum distortion (C102, C103, C104, C105).
7. Repeat Steps 5 and 6 until no further adjustment is necessary.
8. Adjust the secondary core (upper) of the discriminator transformer L201 until the center tuning meter pointer indicates center on noise (no signal applied). Set the generator to 98MHz and increase its output level to $1\text{K}\mu\text{V}$ and tune the receiver to the same frequency so that the center tuning meter pointer indicates center. Adjust the primary core (lower) of L201 for minimum distortion.
9. Set the generator to 98MHz and increase its output to $100\text{K}\mu\text{V}$. Adjust R374 so that the signal strength meter reads 90% of full scale deflection.

12. STEREO SEPARATION ALIGNMENT

1. Set the FM signal generator to provide $1\text{K}\mu\text{V}$ output at 98MHz. Tune the receiver to the same frequency so that the center tuning meter pointer indicates center. Then turn off the modulation of the generator, connect a frequency counter to the test point J310 (point ©) and adjust R311 so that the frequency counter precisely reads 19kHz.
2. Modulate the generator with a stereo composite signal consisting of only L or R channel (of course, the pilot signal must be included).
3. Adjust the trimming resistor R301 for maximum and same separation in both channels.

13. MUTING CIRCUIT ALIGNMENT

1. Connect a VTVM to the center terminal of potentiometer with R363 and adjust R363 until the meter reads 0.75V DC no RF input signal.

2. Set the FM signal generator to provide $1\text{K}\mu\text{V}$ at 98MHz and accurately tune the receiver to the same frequency.
3. Turn the MUTING pushswitch on. Shift the FM signal generator frequency higher and lower and note both higher and lower shifted frequencies at which undesirable audio side responses are muted out. Adjust the R363 so that the same shifted frequencies mute the undesirable side responses.
4. Adjust R362 for preferred frequency shift at which the muting circuit operates.

14. FM DOLBY LEVEL ADJUSTMENT

1. Set the FM SG to provide a 400Hz, 50% modulated 98MHz mono signal, at $1\text{K}\mu\text{V}$ output. Precisely tune the receiver to 98MHz.
2. Depress the FM DOLBY pushswitch, and adjust RC01 and RC02 until the outputs of both channels are 580mV.

15. AUDIO ADJUSTMENTS

1. 35V B+ voltage adjustment (Power Supply)
Connect a DC voltmeter between the pins J804 and J805, and adjust the trimming resistor R806 for 35V DC.
2. Main Amplifier DC offset adjustment.
Connect a DC voltmeter with 0.5 or 1V range across the speaker terminals and adjust the trimming resistor R741 for "zero" DC output on the meter.
Repeat the same procedure for the other channel.
Note: During this alignment no load should be connected to the speaker terminals.
3. Idle-current adjustment
Connect a VTVM between pins ~~J707~~^{J703} and ~~J708~~^{J704} (or T.P.'s J711 and J712). Next, rotate the trimming resistor R742 fully counterclockwise, then rotate it clockwise until the VTVM reads 10mV DC (25mA).
Repeat the same procedure for the other channel.
Note: During this alignment no load should be connected to the speaker terminals.
4. Re-check the DC offset voltage per procedure 2 and if any DC output is observed on the DC voltmeter, adjust R741 again for "zero" output.
5. Phono-amplifier adjustment
Connect an oscilloscope to the TAPE MONITOR OUT jacks and an audio signal generator to the PHONO jacks. Place the selector switch in the PHONO position. Increase the 1kHz audio signal level gradually until a slight clipping on top of the sine-wave is observed on the oscilloscope. Adjust the trimming resistor R408 for equal clipping level.
For the other channel, adjust R409.

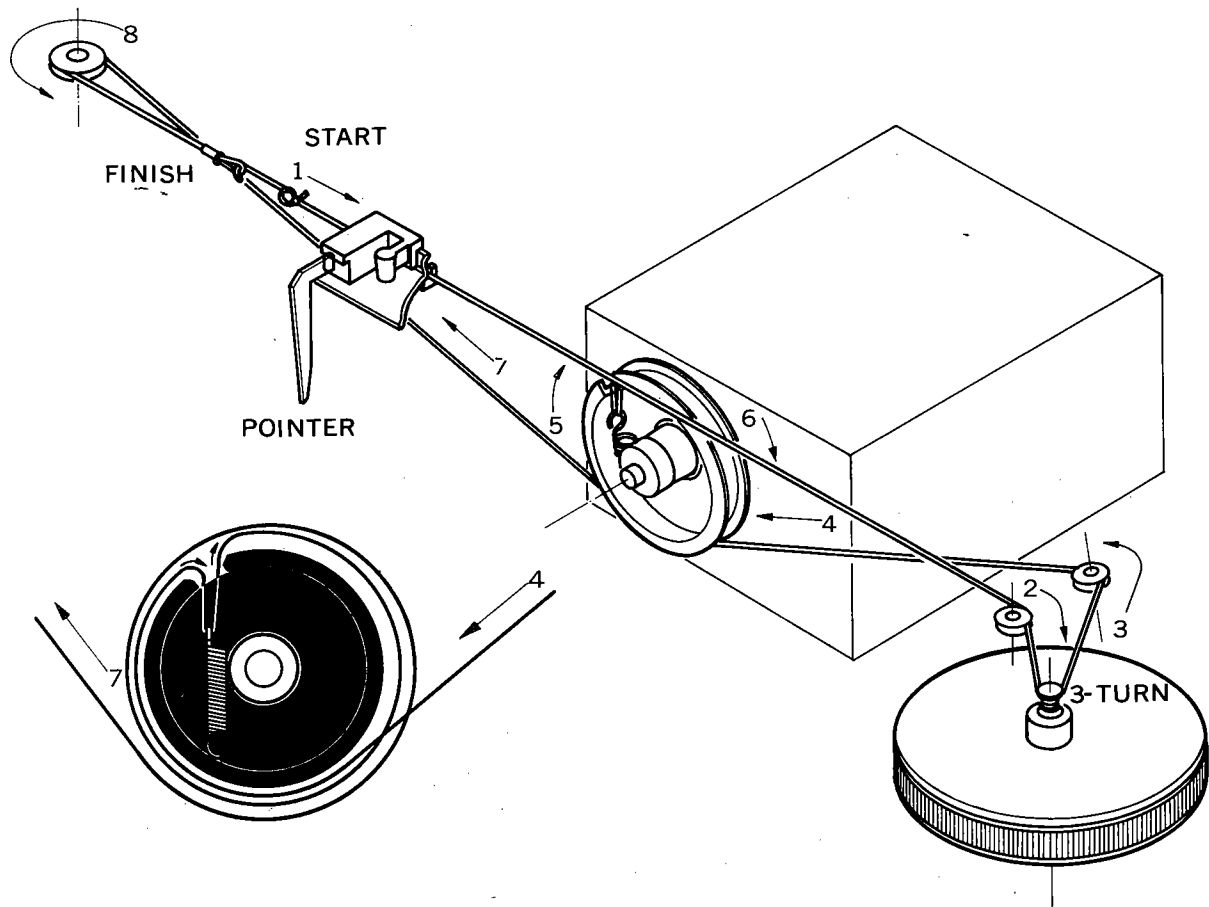

Figure 2. Dial Stringing

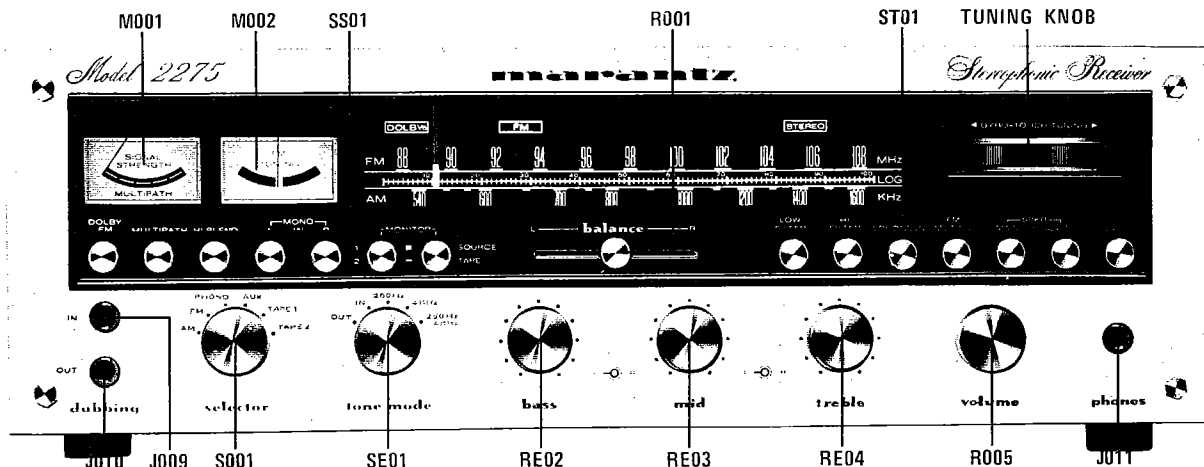

Figure 3. Front Panel Adjustments and Component Locations

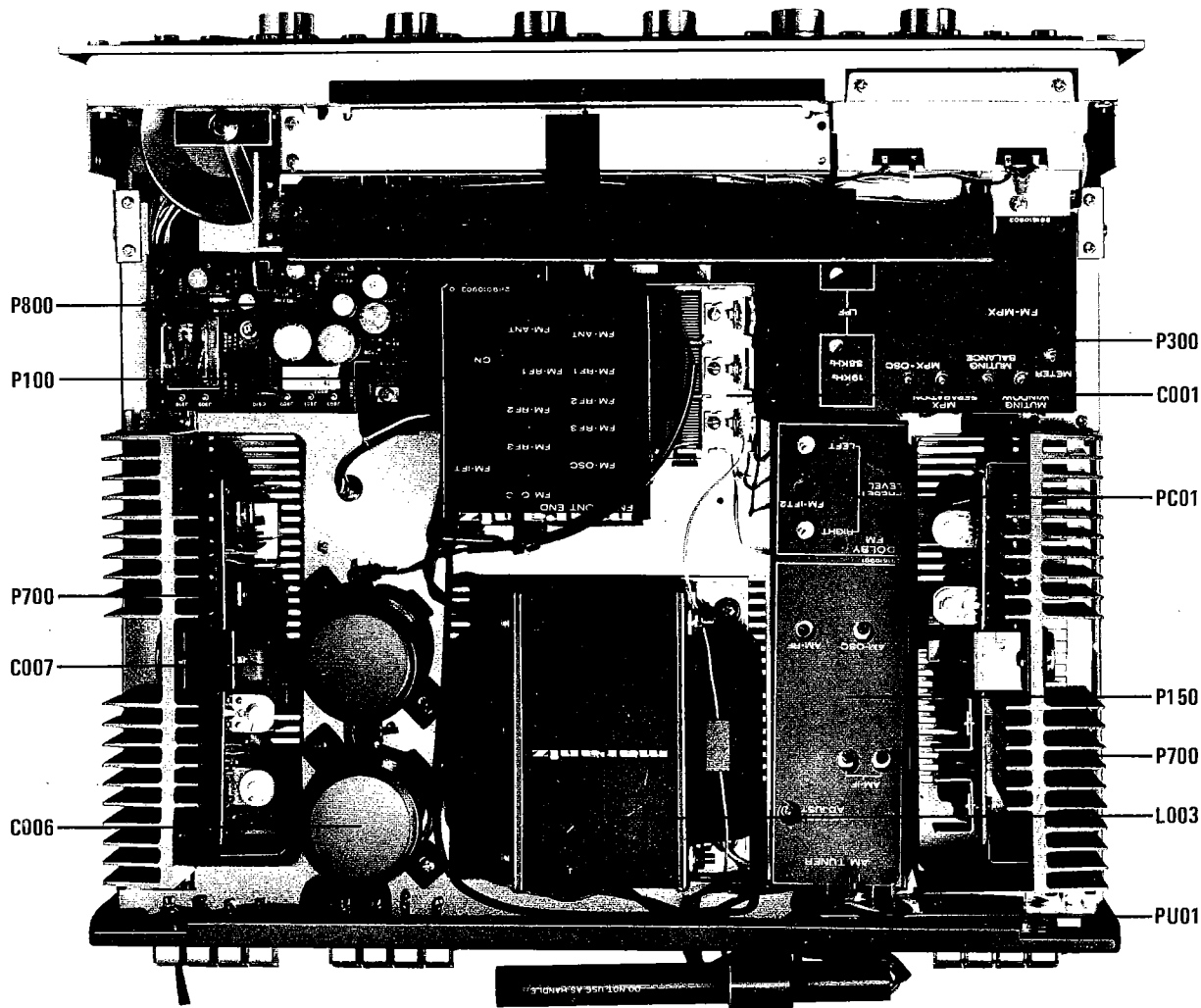

Figure 4. Main Chassis Component Locations (Top View)

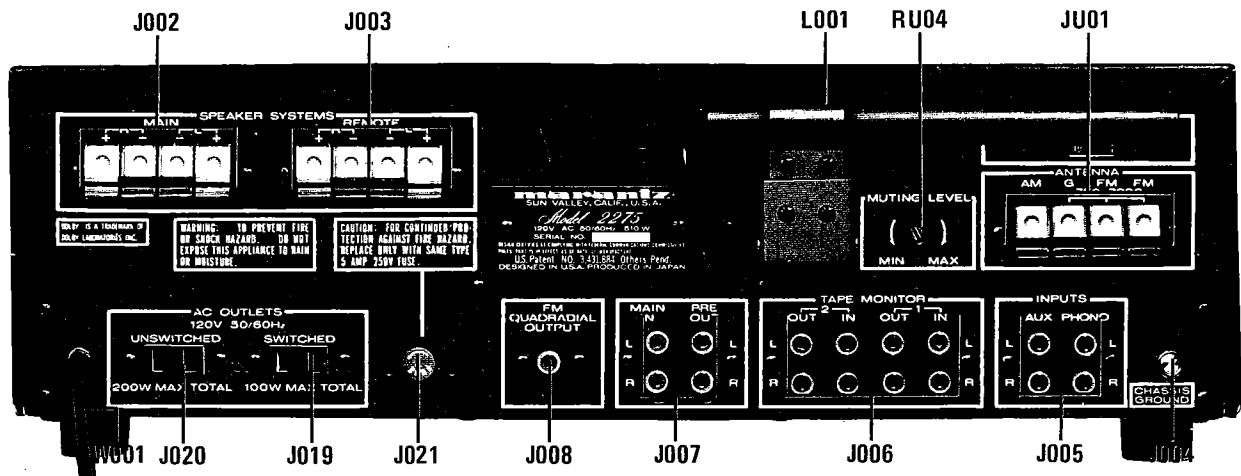

Figure 5. Rear Panel Jacks and Component Locations

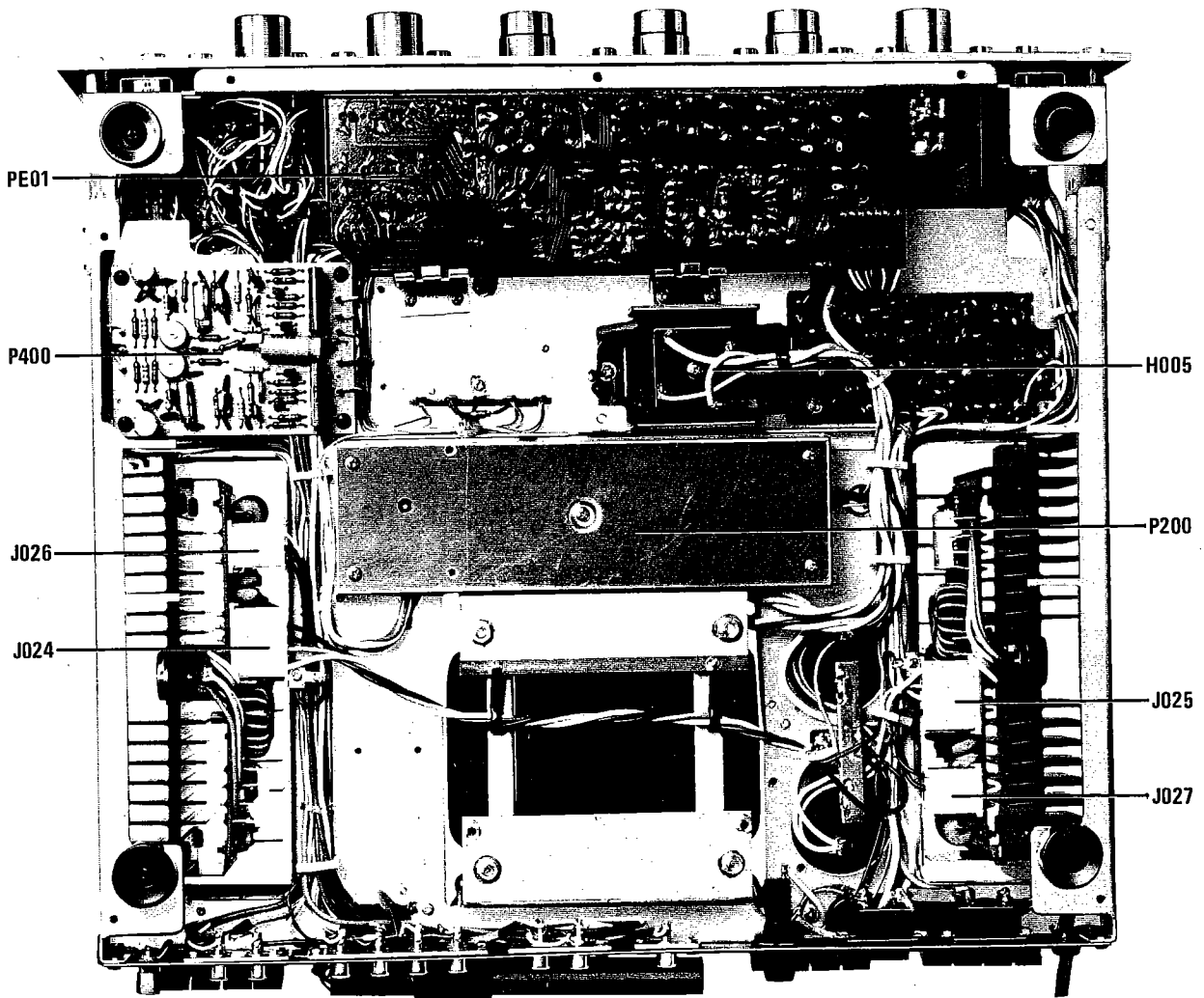

Figure 6. Main Chassis Component Locations (Bottom View)

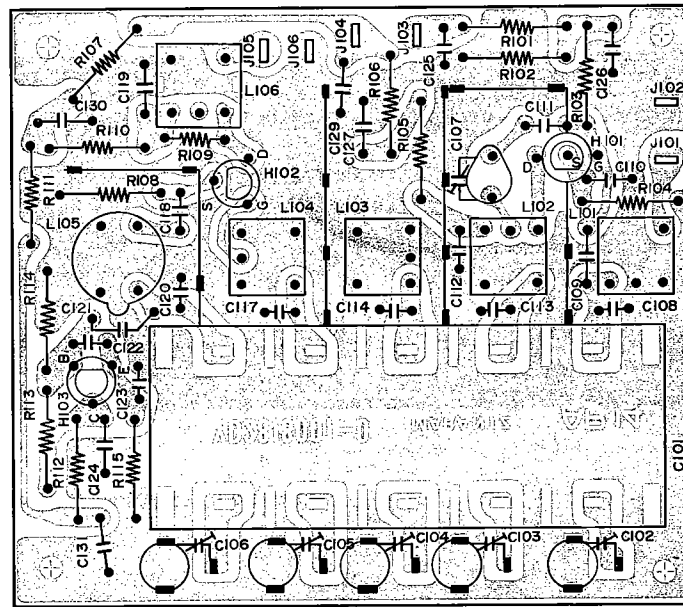

Figure 7. FM Front End Assembly P100 Component Locations

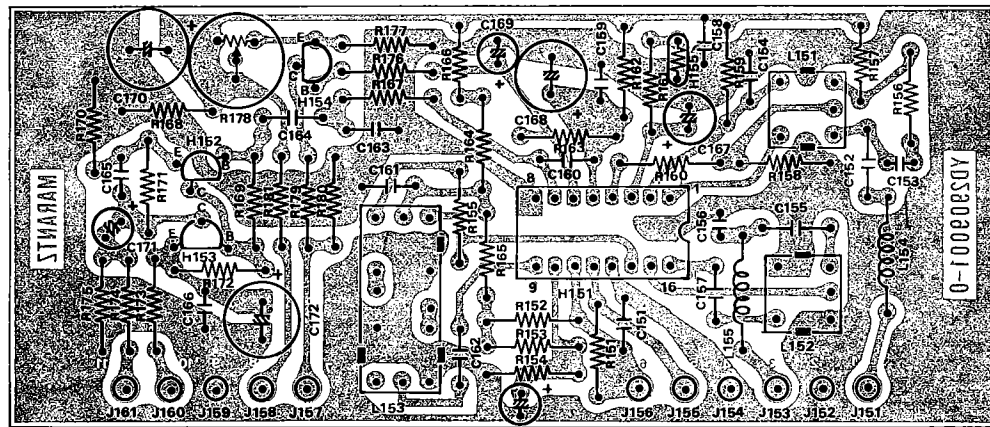

Figure 8. AM Tuner Assembly P150 Component Locations

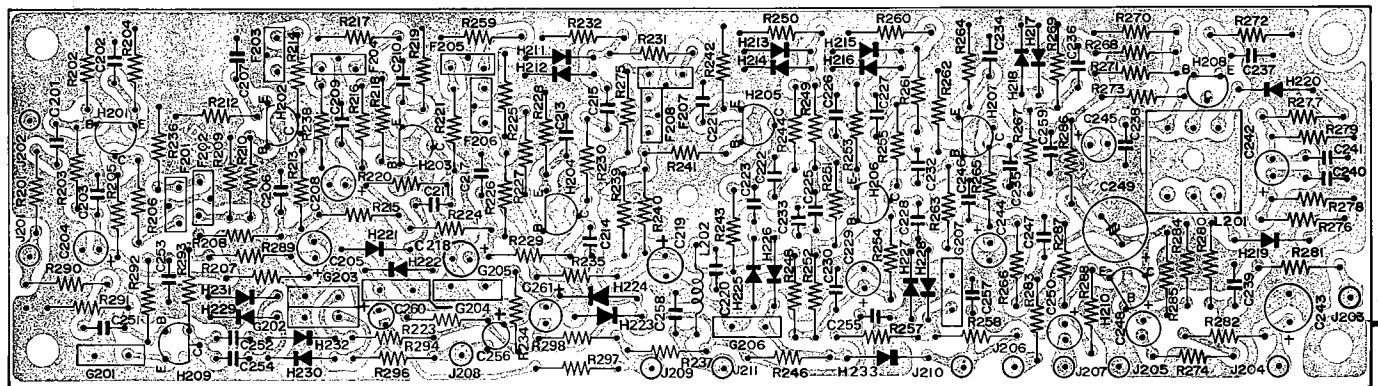

Figure 9. FM IF Amplifier Assembly P200 Component Locations

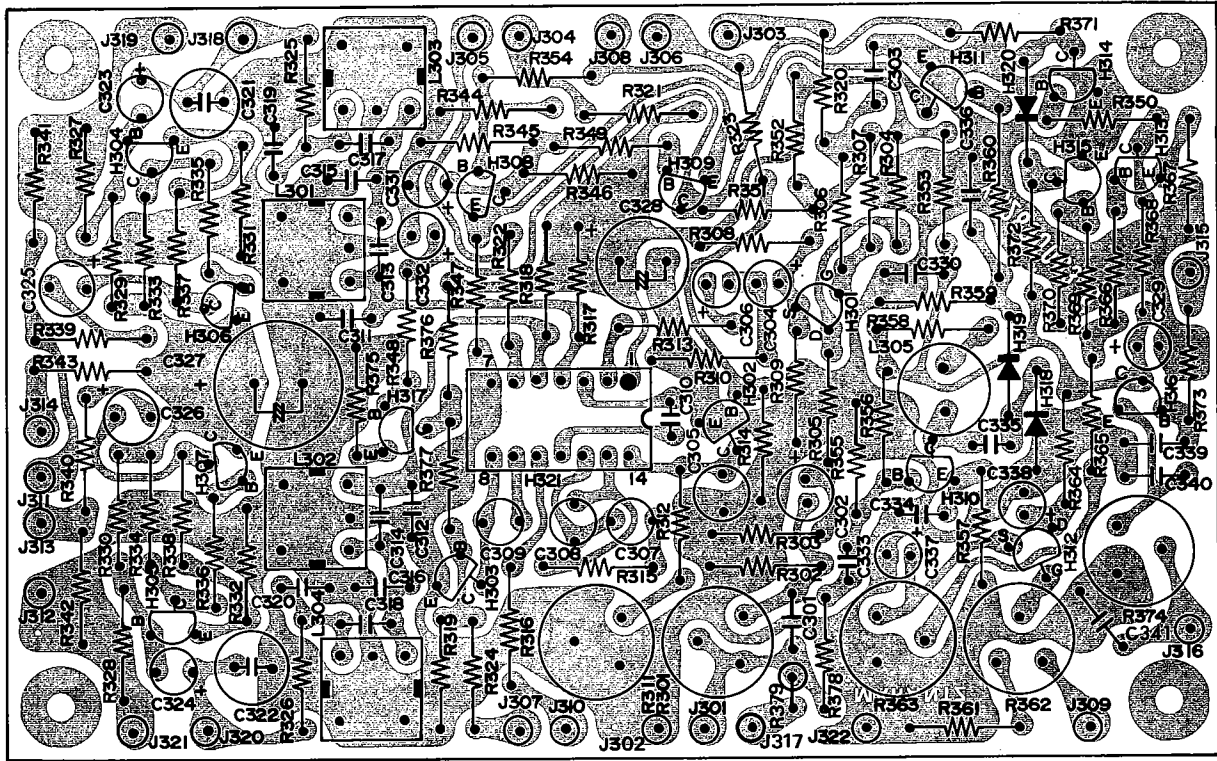

Figure 10. MPX Stereo Decoding Amplifier Assembly P300 Component Locations

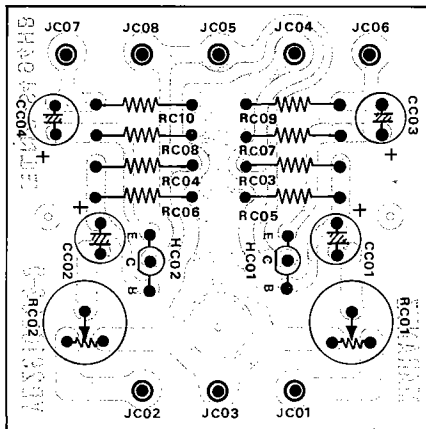

Figure 11. Dolby FM Level Amplifier Assembly PC01 Component Locations

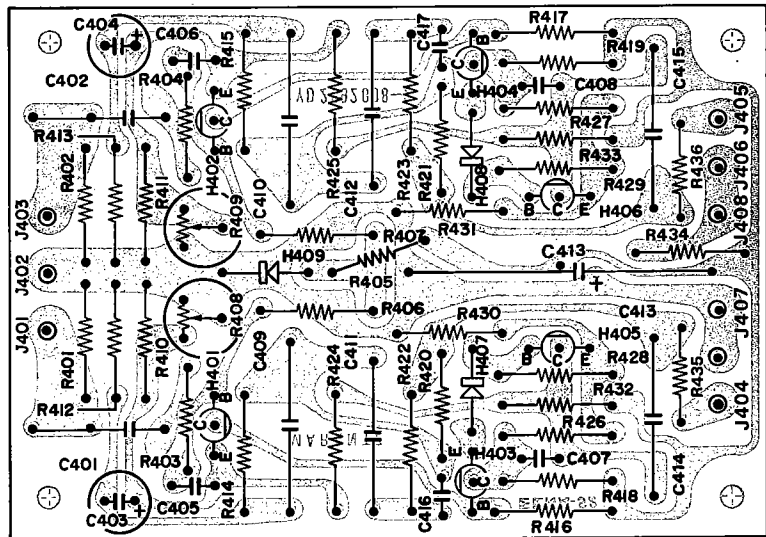

Figure 12. Phono Amplifier Assembly P400 Component Locations

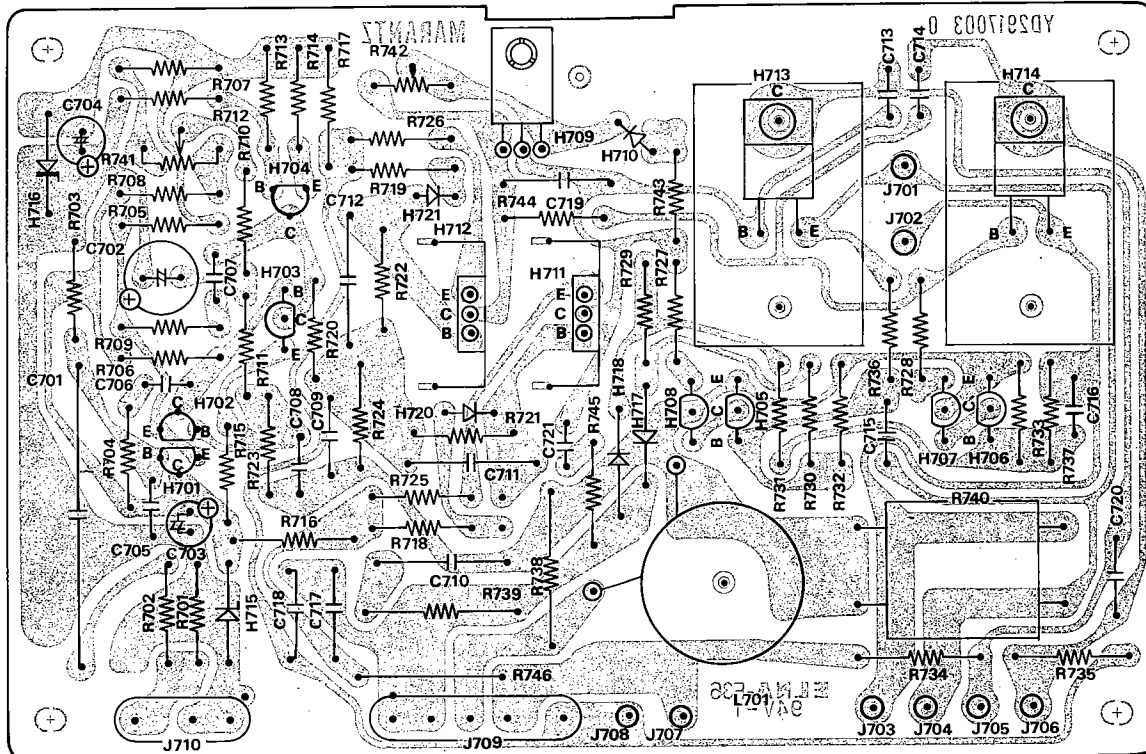

Figure 13. Power Amplifier Assembly P700 Component Locations

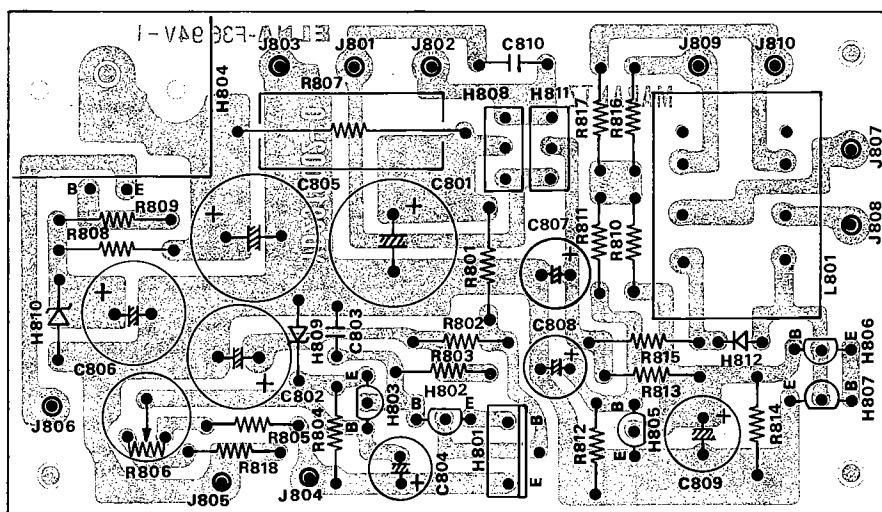

Figure 14. Power Supply and Protection Relay Circuit Assembly P800 Component Locations

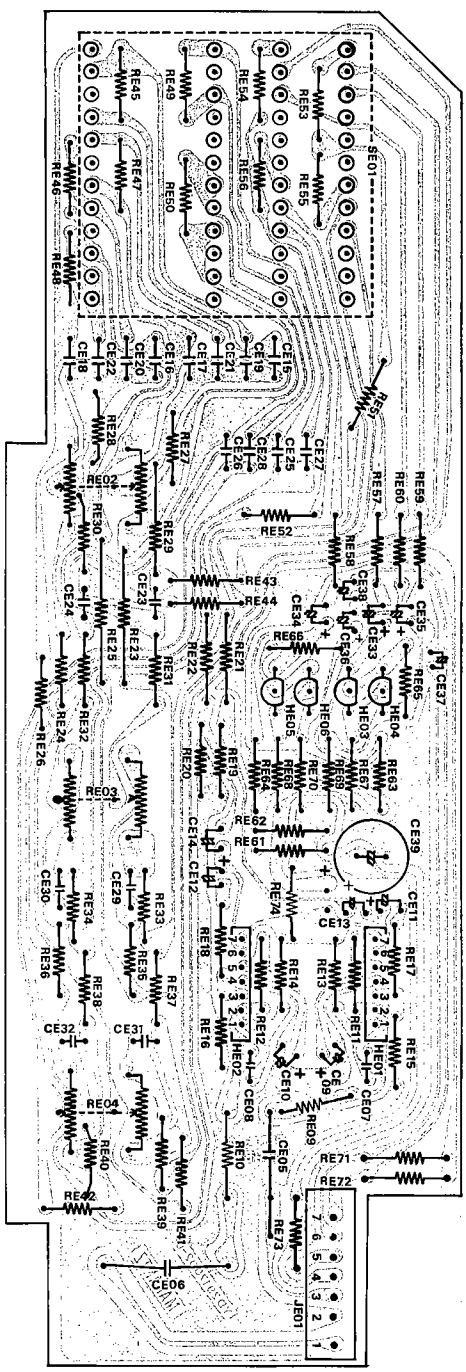

Figure 15. Pre and Tone Amplifier Assembly PE01 Component Locations

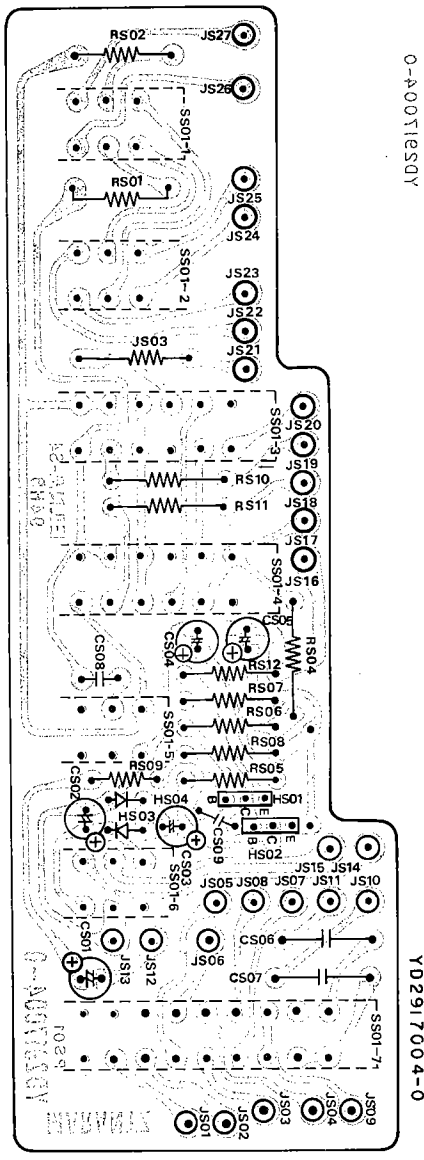

Figure 16. Dolby FM, Mono L, R, Multipath and Monitor Switches Assembly PS01 Component Locations

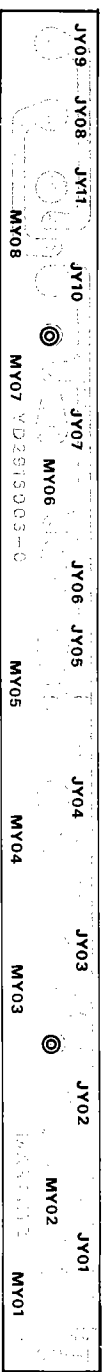

Figure 18. Function Lamps Assembly PY01 Component Locations

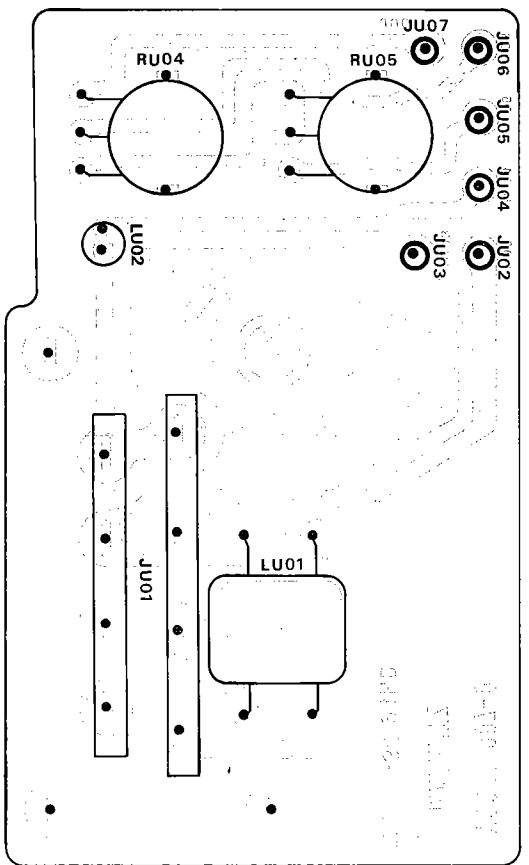

Figure 19. Muting Level and Antenna Attenuator Assembly PU01 Component Locations



Figure 20. Dial Scale Illuminator Assembly PZ01 Component Locations

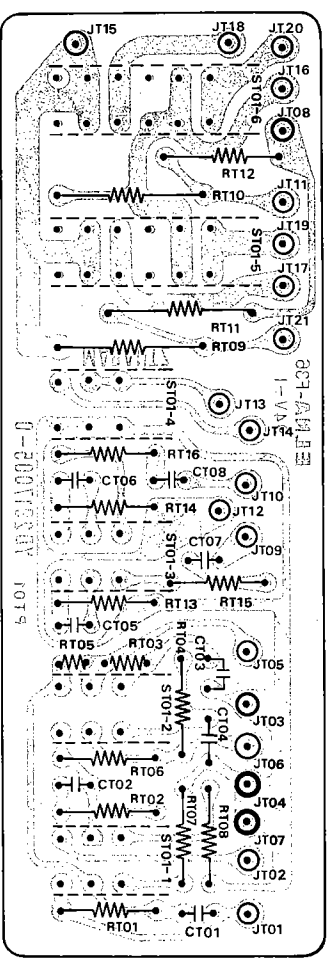

Figure 17. Muting, Speaker, Loudness, Power, Hi and Low Filter Switches PT01 Component Locations

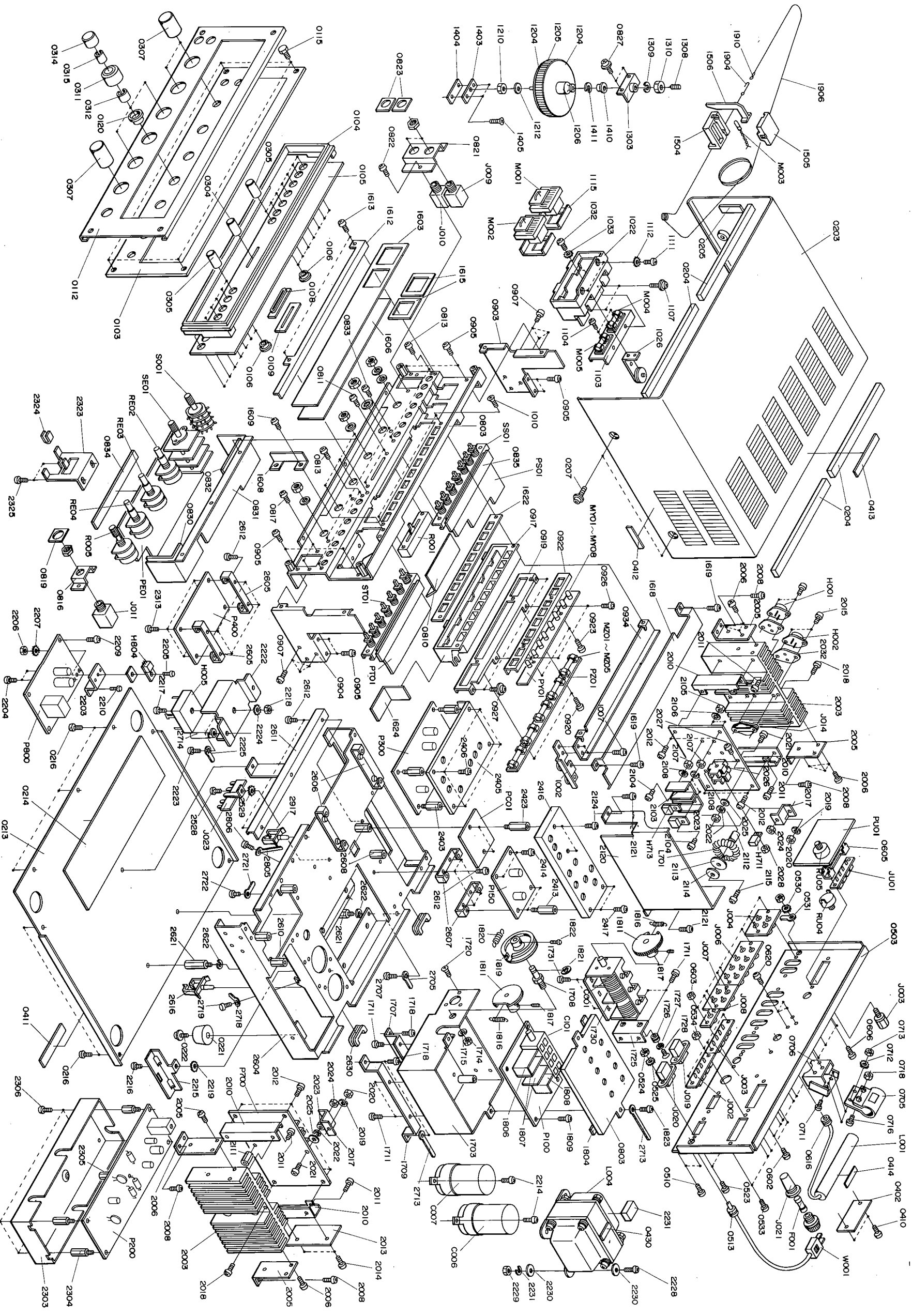

Figure 21. Exploded Mechanical Diagram

PARTS LIST

U U.S.A.
E Europe

REF. DESIG.	U	E	PART NO.	DESCRIPTION
A	1	1	291706340	Front Panel Assembly
0103	1	1	291706301	Escutcheon
0104	1	1	285340101	Frame
0105	1	1	291715801	Window
0106	14	14	288625901	Bush
0108	1	1	285425901	Bush
0109	1	1	291510701	Sheet
0112	1	1	291705301	Cover
B	3	3	281815440	Knob Assembly
0311	3	3	281815404	Knob
0312	3	3	71400149Q	Spring
C	3	3	281815441	Knob Assembly
0314	3	3	281815405	Knob
0315	3	3	71400159Q	Spring
D	1	1	285327340	Fly Wheel Assembly
1204	2	2	257706302	Escutcheon
1205	1	1	257727301	Fly Wheel
1206	1	1	285311201	Shaft
1210	1	1	53110603E	Hexagon Nut
1212	1	1	54020601E	Flat Washer
E	1	1	291510340	Pointer Assembly
1504	1	1	291510301	Pointer
1505	1	1	291510302	Pointer
1506	1	1	281810302	Pointer
M003	1	1	IN1008030	Lamp
F	1	1	120200640	Hook Assembly
1904	1	1	120225801	Hook
1906	1	1	72080802A	String
GENERAL MISCELLANEOUS				
1809	4	4	51100306S	B. H. M. Screw
1816	2	2	71101669Q	Spring
1821	1	1	64000400R	RG Ring E
P100	1	1	YD2818001	FM RF CIRCUIT BOARD-P100
	1	1	ZZ2917101	P.W. Board, FM RF (Print Only)
				P.W. Board Assembly
P100-RESISTORS				
All resistors are $\pm 5\%$ and $\frac{1}{4}W$.				
R101	1	1	RT0556314	56K Ω
R102	1	1	RT0510514	1M Ω
R103	1	1	RT0510414	100K Ω
R104	1	1	RT0510114	100 Ω
R105	1	1	RT0522114	220 Ω
R106	1	1	RT0510114	100 Ω
R107	1	1	RT0510114	100 Ω
R108	1	1	RT0547214	4.7K Ω
R109	1	1	RT0522314	22K Ω
R110	1	1	RT0510214	1K Ω
R111	1	1	RT0510114	100 Ω
R112	1	1	RT0510114	100 Ω
R113	1	1	RT0522314	22K Ω
R114	1	1	RT0522314	22K Ω
R115	1	1	RT0512214	1.2K Ω

REF. DESIG.	U	E	PART NO.	DESCRIPTION
P100-CAPACITORS				
C101	1	1	CA5000001	Variable, FM 5 GANG
C102	1	1	CT1100001	Trimming, 1.5~11.5PF NPO
C103	1	1	CT1100001	Trimming, 1.5~11.5PF NPO
C104	1	1	CT1100001	Trimming, 1.5~11.5PF NPO
C105	1	1	CT1100001	Trimming, 1.5~11.5PF NPO
C106	1	1	CT1100001	Trimming, 1.5~11.5PF NPO
C107	1	1	CT1100002	Trimming, 1.5~11.5PF NPO
C108	1	1	DD1615001	Ceramic, 15PF $\pm 10\%$, 50V
C109	1	1	DK1710201	Ceramic, 0.001 μ F $\pm 20\%$, 50V
C110	1	1	DK1810301	Ceramic, 0.01 μ F +100%, -0%, 50V
C111	1	1	DD1105001	Ceramic, 5PF $\pm 0.5PF$
C112	1	1	DK1710201	Ceramic, 0.001 μ F $\pm 20\%$
C113	1	1	DD1615001	Ceramic, 15PF $\pm 10\%$
C114	1	1	DD1620001	Ceramic, 20PF $\pm 10\%$
C115	1	1	DD1001002	Ceramic, 1.0PF $\pm 0.25PF$
C116	1	1	DD1600601	Ceramic, 0.6PF $\pm 10\%$
C117	1	1	DD1620001	Ceramic, 20PF $\pm 10\%$
C118	1	1	DK1710201	Ceramic, 0.001 μ F $\pm 20\%$
C119	1	1	DK1710301	Ceramic, 0.01 μ F $\pm 20\%$
C120	1	1	DD1620003	Ceramic, 20PF $\pm 10\%$
C121	1	1	DD1210006	Ceramic, 10PF $\pm 10\%$
C122	1	1	DD1615003	Ceramic, 15PF $\pm 10\%$
C123	1	1	DD1615003	Ceramic, 15PF $\pm 10\%$
C124	1	1	DK1710301	Ceramic, 0.01 μ F $\pm 20\%$
C125	1	1	DK1810301	Ceramic, 0.01 μ F +100%, -0%
C126	1	1	DK1810301	Ceramic, 0.01 μ F + 100%, -0%
C127	1	1	DK1710301	Ceramic, 0.01 μ F $\pm 20\%$
C129	1	1	DK1710301	Ceramic, 0.01 μ F $\pm 20\%$
C130	1	1	DK1710301	Ceramic, 0.01 μ F $\pm 20\%$
C131	1	1	DK1710301	Ceramic, 0.01 μ F $\pm 20\%$
P100-COILS & TRANSF.				
L101	1	1	LA1027801	Ant. Coil
L102	1	1	LA1027802	RF Coil
L103	1	1	LA1027803	RF Coil
L104	1	1	LA1027804	RF Coil
L105	1	1	LO1202604	OSC Coil
L106	1	1	LI1001601	IFT
P100-SEMICONDUCTORS & PLUGS				
H101	1	1	HF200191A	Transistor, 2SK19Y
H102	1	1	HF200191A	Transistor, 2SK19Y
H103	1	1	HT305351B	Transistor, 2SC535B
J101	1	1	YP1000094	Plug
J102	1	1	YP1000094	Plug
J103	1	1	YP1000094	Plug
J104	1	1	YP1000094	Plug
J105	1	1	YP1000094	Plug
J106	1	1	YP1000094	Plug
P100-MISCELLANEOUS				
1806	1	1	281810903	Shield
1807	2	2	281810904	Shield
1808	1	1	281810905	Shield
1703	1	1	281810950	Shield K
1707	1	1	281816008	Bracket
1708	1	1	281811201	Shaft
1709	1	1	289016006	Bracket
1711	2	2	51100304A	B. H. M. Screw B 3x4
1714	1	1	53110403E	Hexagon Nut
1715	1	1	54040402N	Spring Washer
1718	4	4	51570306B	P. H. Tapt Screw P 3x6 ST
1720	3	3	51100304E	B. H. M.Screw B 3x4
1725	1	1	281810908	Shield

REF. DESIG.	U	E	PART NO.	DESCRIPTION
1726	2	2	114325901	Bush
1727	2	2	114325902	Bush
1728	2	2	51040308A	F. H. M. Screw F 3x8
1730	1	1	281805102	Guide
1734	3	3	51060305E	P. H. M. Screw P 3x5
C001	1	1	CA0330002	Variable Cap.
1819	1	1	281815901	Drum
1820	1	1	71101569M	Spring
1811	2	2	281805850	Gear K
1817	4	4	51650304D	Set Screw HP
P150	1	1	YD2909001	AM TUNER CIRCUIT BOARD-P150 P. W. Board, AM Tuner (Print Only)
	1	1	ZZ2917201	P. W. Board Assembly
P150-RESISTORS All resistors are $\pm 5\%$ and $\frac{1}{4}W$, unless otherwise indicated.				
R151	1	1	RT0510314	10K Ω
R152	1	1	RT0530314	30K Ω
R153	1	1	RT0582314	82K Ω
R154	1	1	RT0522314	22K Ω
R156	1	1	RT0515414	150K Ω
R157	1	1	RC0000014	0 Ω
R158	1	1	RT0539314	39K Ω
R159	1	1	RT0539214	3.9K Ω
R160	1	1	RC0000012	0 Ω
R161	1	1	RT0543214	4.3K Ω
R162	1	1	RT0510114	100 Ω
R163	1	1	RT0515214	1.5K Ω
R164	1	1	RT0533114	330 Ω
R165	1	1	RC0000014	0 Ω
R166	1	1	RC0000014	0 Ω
R167	1	1	RT0522214	2.2K Ω
R168	1	1	RT0582314	82K Ω
R169	1	1	RT0562414	620K Ω
R170	1	1	RT0551114	510 Ω
R171	1	1	RT0520214	2K Ω
R172	1	1	RT0556214	5.6K Ω
R173	1	1	RT0510114	100 Ω
R174	1	1	RT0510114	100 Ω
R175	1	1	RT0510414	100K Ω
R176	1	1	RT0510314	10K Ω
R177	1	1	RT0512314	12K Ω
R178	1	1	RA0103025	Trimming, 10K Ω (B)
R179	1	1	RT0512314	12K Ω
R180	1	1	RT0515214	1.5K Ω
R181	1	1	RT0510114	100 Ω
R182	1	1	RT0515214	1.5K Ω
P-150 - CAPACITORS				
C151	1	1	DK1710301	Ceramic, 0.01 μF $\pm 20\%$
C152	1	1	DF1747305	Film, 0.047 μF $\pm 20\%$
C153	1	1	DD1620001	Ceramic, 20PF $\pm 10\%$
C154	1	1	DK1710301	Ceramic, 0.01 μF $\pm 20\%$
C155	1	1	DF6545101	Film, 450PF $\pm 5\%$
C156	1	1	DD1615001	Ceramic, 15PF $\pm 10\%$
C157	1	1	DK1710301	Ceramic, 0.01 μF $\pm 20\%$
C158	1	1	DK1840302	Ceramic, 0.04 μF $+80\%, -20\%$
C159	1	1	DK1840302	Ceramic, 0.04 μF $+80\%, -20\%$
C160	1	1	DK1710301	Ceramic, 0.01 μF $\pm 20\%$

REF. DESIG.	U	E	PART NO.	DESCRIPTION
C161	1	1	DK1710301	Ceramic, 0.01 μF $\pm 20\%$
C162	1	1	DK1710301	Ceramic, 0.01 μF $\pm 20\%$
C163	1	1	DF1615305	Film, 0.015 μF $\pm 10\%$
C164	1	1	DF1633305	Film, 0.033 μF $\pm 10\%$
C165	1	1	DF1756205	Film, 0.0056 μF $\pm 20\%$
C166	1	1	DK1840302	Film, 0.04 μF $+80\%, -20\%$
C167	1	1	EA2260169	Electroly, 22 μF , 16V
C168	1	1	EA1070169	Electroly, 100 μF , 16V
C169	1	1	EA4750359	Electroly, 4.7 μF , 35V
C170	1	1	EA1070169	Electroly, 100 μF , 16V
C171	1	1	EA1050509	Electroly, 1 μF , 50V
C172	1	1	EA1070169	Electroly, 100 μF , 16V
C173	1	1	EA4750359	Electroly, 4.7 μF , 35V
P150-SEMICONDUCTORS				
H151	1	1	HC1000506	I C, $\mu PC30C$
H152	1	1	HT313272A	Transistor, 2SC1327 S.T
H153	1	1	HT104942A	Transistor, 2SA494 Y.G
H154	1	1	HT104942A	Transistor, 2SA494 Y.G
H155	1	1	HH0000212	Thermistor, 31D27
P150-COILS & TRANSF.				
L151	1	1	LA1001019	RF Coil, AM
L152	1	1	LO1001050	OSC Coil, AM
L153	1	1	LI1028003	I F T, AM Ceramic Filter
L154	1	1	LC1332002	Choke Coil, 3.3 μH
L155	1	1	LC1332002	Choke Coil, 3.3 μH
P150-PLUGS				
J151	1	1	YP1000113	Plug
J152	1	1	YP1000113	Plug
J153	1	1	YP1000113	Plug
J155	1	1	YP1000113	Plug
J156	1	1	YP1000113	Plug
J157	1	1	YP1000113	Plug
J158	1	1	YP1000113	Plug
J159	1	1	YP1000113	Plug
J160	1	1	YP1000113	Plug
J161	1	1	YP1000113	Plug
P200	1	1	YD2917001	FM IF CIRCUIT BOARD-P200 P. W. Board, FM IF (Print Only)
	1	1	ZZ2917001	P. W. Board Assembly
P200-RESISTORS All resistors are $\pm 5\%$ and $\frac{1}{4}W$, unless otherwise indicated.				
R201	1	1	RT0515114	150 Ω
R202	1	1	RT0582214	8.2K Ω
R203	1	1	RT0518314	18K Ω
R204	1	1	RT0510214	1K Ω
R205	1	1	RT0533114	330 Ω
R206	1	1	RC0000014	0 Ω , $\frac{1}{4}W$
R207	1	1	RT0547014	47 Ω
R208	1	1	RT0533214	3.3K Ω
R209	1	1	RT0515214	1.5K Ω
R210	1	1	RT0515114	150 Ω
R212	1	1	RT0510214	1K Ω
R213	1	1	RT0533114	330 Ω
R214	1	1	RC0000014	0 Ω , $\frac{1}{4}W$
R215	1	1	RT0547014	47 Ω
R216	1	1	RT0533214	3.3K Ω
R217	1	1	RT0515214	1.5K Ω
R218	1	1	RT0515114	150 Ω
R219	1	1	RT0510214	1K Ω

U U.S.A.
E Europe

REF. DESIG.	U	E	PART NO.	DESCRIPTION
R220	1	1	RT0533114	330Ω
R221	1	1	RC0000014	0Ω, ¼W
R223	1	1	RT0547314	47KΩ
R224	1	1	RT0547014	47Ω
R225	1	1	RT0515214	1.5KΩ
R226	1	1	RT0533214	3.3KΩ
R227	1	1	RT0515114	150Ω
R228	1	1	RT0556114	560Ω
R229	1	1	RT0575014	75Ω
R230	1	1	RC0000014	0Ω, ¼W
R231	1	1	RT0575014	75Ω
R232	1	1	RT0510414	100KΩ
R234	1	1	RT0568314	68KΩ
R235	1	1	RT0547014	47Ω
R236	1	1	RT0582114	820Ω
R237	1	1	RT0510214	1KΩ
R238	1	1	RT0582114	820Ω
R239	1	1	RT0515214	1.5KΩ
R240	1	1	RT0533214	3.3KΩ
R241	1	1	RT0515114	150Ω
R242	1	1	RT0510214	1KΩ
R243	1	1	RT0510214	1KΩ
R244	1	1	RT0515114	150Ω
R246	1	1	RT0568314	68KΩ
R248	1	1	RT0547014	47Ω
R249	1	1	RT0515114	150Ω
R250	1	1	RT0510414	100KΩ
R251	1	1	RT0582214	8.2KΩ
R252	1	1	RT0515314	15KΩ
R253	1	1	RT0510214	1KΩ
R254	1	1	RT0510214	1KΩ
R255	1	1	RT0515114	150Ω
R257	1	1	RT0539314	39KΩ
R258	1	1	RT0522314	22KΩ
R259	1	1	RT0582114	820Ω
R260	1	1	RT0510414	100KΩ
R261	1	1	RT0515114	150Ω
R262	1	1	RT0582214	8.2KΩ
R263	1	1	RT0515314	15KΩ
R264	1	1	RT0510214	1KΩ
R265	1	1	RT0510214	1KΩ
R266	1	1	RT0510114	100Ω
R267	1	1	RT0515114	150Ω
R268	1	1	RT0515114	150Ω
R269	1	1	RT0510414	100KΩ
R270	1	1	RT0582214	8.2KΩ
R271	1	1	RT0515314	15KΩ
R272	1	1	RT0510214	1KΩ
R273	1	1	RT0510114	100Ω
R274	1	1	RT0527214	2.7KΩ
R275	1	1	RT0582114	820Ω
R276	1	1	RT0582114	820Ω
R277	1	1	RT0582114	820Ω
R278	1	1	RT0568214	6.8KΩ
R279	1	1	RT0568214	6.8KΩ
R280	1	1	RT0510114	100Ω
R281	1	1	RT0556314	56KΩ
R282	1	1	RT0522314	22KΩ
R283	1	1	RT0510114	100Ω
R284	1	1	RT0510414	100KΩ
R285	1	1	RT0518414	180KΩ
R286	1	1	RT0510114	100Ω

REF. DESIG.	U	E	PART NO.	DESCRIPTION
R287	1	1	RT0522214	2.2KΩ
R288	1	1	RT0510114	100Ω
R289	1	1	RT0510114	100Ω
R290	1	1	RT0512114	120Ω
R291	1	1	RT0582214	8.2KΩ
R292	1	1	RT0518314	18KΩ
R293	1	1	RT0522214	2.2KΩ
R294	1	1	RT0527314	27KΩ
R296	1	1	RT0533314	33KΩ
R297	1	1	RT0522314	22KΩ
R298	1	1	RT0515314	15KΩ
P200-CAPACITORS				
C201	1	1	DK1810301	Ceramic, 0.01μF +80%,-20%
C202	1	1	DK1810301	Ceramic, 0.01μF +80%,-20%
C203	1	1	DK1840302	Ceramic, 0.04μF +80%,-20%
C204	1	1	EA1060169	Electroly, 10μF, 16V
C205	1	1	EA1060169	Electroly, 10μF, 16V
C206	1	1	DK1840302	Ceramic, 0.04μF +80%,-20%
C207	1	1	DK1810301	Ceramic, 0.01μF +80%,-20%
C208	1	1	EA1060169	Electroly, 10μF, 16V
C209	1	1	DK1840302	Ceramic, 0.04μF +80%,-20%
C210	1	1	DK1810301	Ceramic, 0.01μF +80%,-20%
C211	1	1	DD1540001	Ceramic, 40PF ±5%
C213	1	1	DK1810301	Ceramic, 0.01μF +80%,-20%
C214	1	1	DD1540001	Ceramic, 40PF ±5%
C215	1	1	DK1810301	Ceramic, 0.01μF +80%,-20%
C217	1	1	DK1840302	Ceramic, 0.04μF +80%,-20%
C218	1	1	EA1060169	Electroly, 10μF, 16V
C219	1	1	EA1060169	Electroly, 10μF, 16V
C220	1	1	DK1840302	Ceramic, 0.04μF +80%,-20%
C221	1	1	DK1810301	Ceramic, 0.01μF +80%,-20%
C222	1	1	DK1810301	Ceramic, 0.01μF +80%,-20%
C223	1	1	DD1540001	Ceramic, 40PF ±5%
C225	1	1	DK1810301	Ceramic, 0.01μF +80%,-20%
C226	1	1	DK1810301	Ceramic, 0.01μF +80%,-20%
C227	1	1	DK1810301	Ceramic, 0.01μF +80%,-20%
C228	1	1	DD1540001	Ceramic, 40PF ±5%
C229	1	1	EA1060169	Electroly, 10μF, 16V
C230	1	1	DK1840302	Ceramic, 0.04μF +80%,-20%
C232	1	1	DK1810301	Ceramic, 0.01μF +80%,-20%
C233	1	1	DD1540001	Ceramic, 40PF ±5%
C234	1	1	DK1810301	Ceramic, 0.01μF +80%,-20%
C235	1	1	DK1810301	Ceramic, 0.01μF +80%,-20%
C236	1	1	DK1810301	Ceramic, 0.01μF +80%,-20%
C237	1	1	DK1810301	Ceramic, 0.01μF +80%,-20%
C238	1	1	DK1840302	Ceramic, 0.04μF +80%,-20%
C239	1	1	DD1620101	Ceramic, 200PF ±10%
C240	1	1	DD1620101	Ceramic, 200PF ±10%
C241	1	1	DD1620101	Ceramic, 200PF ±10%
C242	1	1	EA1060169	Electroly, 10μF, 16V
C243	1	1	EA1070109	Electroly, 100μF, 10V
C244	1	1	EA1060169	Electroly, 10μF, 16V
C245	1	1	EA1060169	Electroly, 10μF, 16V
C246	1	1	DK1840302	Ceramic, 0.04μF, +80%,-20%
C247	1	1	DK1840302	Ceramic, 0.04μF, +80%,-20%
C248	1	1	EA1060169	Electroly, 10μF, 16V
C249	1	1	EA1070169	Electroly, 100μF, 16V
C250	1	1	EA2260169	Electroly, 22μF, 16V
C251	1	1	DK1810301	Ceramic, 0.01μF, +80%,-20%
C252	1	1	DD1540001	Ceramic, 40PF, ±5%
C253	1	1	DK1840302	Ceramic, 0.04μF, +80%,-20%
C254	1	1	DD1540001	Ceramic, 40PF ±5%
C255	1	1	DD1620101	Ceramic, 200PF ±10%

REF. DESIG.	U	E	PART NO.	DESCRIPTION
C256	1	1	EV1050352	Electroly, 1 μ F \pm 20%, 35V
C257	1	1	DD1620101	Ceramic, 200PF \pm 10%
C258	1	1	DK1810301	Ceramic, 0.01 μ F +80%, -20%
C259	1	1	DK1840302	Ceramic, 0.04 μ F +80%, -20%
C260	1	1	EV1050352	Electroly, 1 μ F, 35V
C261	1	1	EA1050509	Electroly, 1 μ F, 50V
C262	1	1	DK1810402	Ceramic 0.1 μ F +80%, -20%
P200-FILTERS, TRANSF. & COIL				
F201	1	1	FP1107001	Ceramic Filter, FA 10.7 M Hz
F202	1	1	FP1107001	Ceramic Filter, FA 10.7 M Hz
F203	1	1	FP1107001	Ceramic Filter, FA 10.7 M Hz
F204	1	1	FP1107001	Ceramic Filter, FA 10.7 M Hz
F205	1	1	FP1107001	Ceramic Filter, FA 10.7 M Hz
F206	1	1	FP1107001	Ceramic Filter, FA 10.7 M Hz
F207	1	1	FP1107001	Ceramic Filter, FA 10.7 M Hz
F208	1	1	FP1107001	Ceramic Filter, FA 10.7 M Hz
L201	1	1	LI1401623	I F T, FM Det.
L202	1	1	LC1332002	Choke Coil, 3.3 μ H
P200-SEMICONDUCTORS				
H201	1	1	HT308291C	Transistor, 2SC829C
H202	1	1	HT308291C	Transistor, 2SC829C
H203	1	1	HT308291C	Transistor, 2SC829C
H204	1	1	HT308291C	Transistor, 2SC829C
H205	1	1	HT308291C	Transistor, 2SC829C
H206	1	1	HT308291C	Transistor, 2SC829C
H207	1	1	HT308291C	Transistor, 2SC829C
H208	1	1	HT308291C	Transistor, 2SC829C
H209	1	1	HT308291C	Transistor, 2SC829C
H210	1	1	HT306441B	Transistor, 2SC644S
H211	1	1	HD2000121	Diode, 1S2473C
H212	1	1	HD2000121	Diode, 1S2473C
H213	1	1	HD2000121	Diode, 1S2473C
H214	1	1	HD2000121	Diode, 1S2473C
H215	1	1	HD2000121	Diode, 1S2473C
H216	1	1	HD2000121	Diode, 1S2473C
H217	1	1	HD2000121	Diode, 1S2473C
H218	1	1	HD2000121	Diode, 1S2473C
H219	1	1	HD1000302	Diode, 20A90M
H220	1	1	HD1000302	Diode, 20A90M
H221	1	1	HD1000105	Diode, IN60
H222	1	1	HD1000105	Diode, IN60
H223	1	1	HD1000105	Diode, IN60
H224	1	1	HD1000105	Diode, IN60
H225	1	1	HD1000105	Diode, IN60
H226	1	1	HD1000105	Diode, IN60
H227	1	1	HD1000105	Diode, IN60
H228	1	1	HD1000105	Diode, IN60
H229	1	1	HD1000105	Diode, IN60
H230	1	1	HD1000105	Diode, IN60
H231	1	1	HD1000105	Diode, IN60
H232	1	1	HD1000105	Diode, IN60
H233	1	1	HD1000302	Diode, 20A90M
P200-MISCELLANEOUS				
J201	1	1	YP1000113	Plug
J202	1	1	YP1000113	Plug
J203	1	1	YP1000113	Plug
J204	1	1	YP1000113	Plug
J205	1	1	YP1000113	Plug
J206	1	1	YP1000113	Plug
J207	1	1	YP1000113	Plug
J208	1	1	YP1000113	Plug
J209	1	1	YP1000113	Plug

REF. DESIG.	U	E	PART NO.	DESCRIPTION
J210	1	1	YP1000113	Plug
J211	1	1	YP1000113	Plug
G201	1	1	BF2230006	Printed Comp. 1K Ω +0.022 μ F
G202	1	1	BF1020002	Printed Comp. 100K Ω +1000PF
G203	1	1	BF1020001	Printed Comp. 27K Ω +1000PF
C204	1	1	BF2010004	Printed Comp. 27K Ω +200PF
G205	1	1	BF2010004	Printed Comp. 27K Ω +200PF
G206	1	1	BF2010004	Printed Comp. 27K Ω +200PF
G207	1	1	BF2010004	Printed Comp. 27K Ω +200PF
FM MPX CIRCUIT BOARD-P300				
P300	1	1	YD2890003	P. W. Board, FM MPX (Print Only)
			ZZ2917103	P. W. Board Assembly
P300-RESISTORS				
All resistors are \pm 5% and $\frac{1}{4}$ W, unless otherwise indicated				
R301	1	1	RA0202011	Trimming, 2K Ω (B)
R302	1	1	RT0522414	220K Ω
R303	1	1	RT0556314	56K Ω
R304	1	1	RT0568314	68K Ω
R305	1	1	RT0510114	100 Ω
R306	1	1	RT0518414	180K Ω
R307	1	1	RT0522414	220K Ω
R308	1	1	RT0512414	120K Ω
R309	1	1	RT0510414	100K Ω
R310	1	1	RT0568214	6.8K Ω
R311	1	1	RA0502020	Trimming, 5K Ω (B)
R312	1	1	RT0516314	16K Ω
R313	1	1	RT0510214	1K Ω
R314	1	1	RT0522414	220K Ω
R315	1	1	RT0510214	1K Ω
R316	1	1	RT0510214	1K Ω
R317	1	1	RT0539214	3.9K Ω
R318	1	1	RT0539214	3.9K Ω
R319	1	1	RT0522414	220K Ω
R320	1	1	RT0522314	22K Ω
R321	1	1	RT0510114	100 Ω
R322	1	1	RT0510014	10 Ω
R323	1	1	RT0522414	220K Ω
R324	1	1	RT0522414	220K Ω
R325	1	1	RT0530314	30K Ω
R326	1	1	RT0530314	30K Ω
R327	1	1	RT0510414	100K Ω
R328	1	1	RT0510414	100K Ω
R329	1	1	RT0515514	1.5M Ω
R330	1	1	RT0515514	1.5M Ω
R331	1	1	RT0551114	510 Ω
R332	1	1	RT0551114	510 Ω
R333	1	1	RT0522314	22K Ω
R334	1	1	RT0522314	22K Ω
R335	1	1	RT0510114	100 Ω
R336	1	1	RT0510114	100 Ω
R337	1	1	RT0582214	8.2K Ω
R338	1	1	RT0582214	8.2K Ω
R339	1	1	RT0547114	470 Ω
R340	1	1	RT0547114	470 Ω
R341	1	1	RT0522414	220K Ω
R342	1	1	RT0522414	220K Ω
R343	1	1	RT0539214	3.9K Ω
R344	1	1	RT0556414	560K Ω
R345	1	1	RT0515314	15K Ω

U U.S.A.
E Europe

REF. DESIG.	U	E	PART NO.	DESCRIPTION
R346	1	1	RT0512414	120K Ω
R347	1	1	RT0510114	100 Ω
R348	1	1	RT0522414	220K Ω
R349	1	1	RT0556214	5.6K Ω
R350	1	1	RT0510314	10K Ω
R351	1	1	RT0510114	100 Ω
R352	1	1	RT0533314	33K Ω
R353	1	1	RT0510114	100 Ω
R354	1	1	RT0510414	100K Ω
R355	1	1	RT0527314	27K Ω
R356	1	1	RT0510414	100K Ω
R357	1	1	RT0510214	1K Ω
R358	1	1	RT0510114	100 Ω
R359	1	1	RT0527314	27K Ω
R360	1	1	RT0533314	33K Ω
R361	1	1	RT0510414	100K Ω
R362	1	1	RA0104018	Trimming, 100K Ω (B)
R363	1	1	RA0103025	Trimming, 10K Ω (B)
R364	1	1	RT0522214	2.2K Ω
R365	1	1	RT0510114	100 Ω
R366	1	1	RT0510314	10K Ω
R367	1	1	RT0510114	100 Ω
R368	1	1	RT0527414	270K Ω
R369	1	1	RT0510314	10K Ω
R370	1	1	RT0512314	12K Ω
R371	1	1	RT0522114	220 Ω
R373	1	1	RT0582314	82K Ω
R374	1	1	RA0103025	Trimming, 10K Ω (B)
R375	1	1	RT0510114	100 Ω
R376	1	1	RT0510414	100K Ω
R377	1	1	RT0510414	100K Ω
R378	1	1	RT0556214	5.6K Ω
R379	1	1	RT0533214	3.3K Ω
P300-CAPACITORS				
C301	1	1	DF1633205	Film, 3300PF \pm 10%
C302	1	1	EA3360109	Electroly, 33 μ F, 10V
C303	1	1	DF1722305	Film, 0.022 μ F \pm 20%
C304	1	1	EA2260169	Electroly, 22 μ F, 16V
C305	1	1	DF5547101	Film, 470PF \pm 5%
C306	1	1	EA2260169	Electroly, 22 μ F, 16V
C307	1	1	EQ4740501	Electroly, 0.47 μ F \pm 20%,50V
C308	1	1	EQ2240501	Electroly, 0.22 μ F \pm 20%,50V
C309	1	1	EQ2240501	Electroly, 0.22 μ F \pm 20%,50V
C310	1	1	DF1747301	Film, 0.047 μ F \pm 20%
C311	1	1	DF1515205	Film, 1500PF \pm 5%
C312	1	1	DF1515205	Film, 1500PF \pm 5%
C313	1	1	DD1536101	Ceramic, 360PF \pm 5%
C314	1	1	DD1536101	Ceramic, 360PF \pm 5%
C315	1	1	DF1533205	Film, 3300PF \pm 5%
C316	1	1	DF1533205	Film, 3300PF \pm 5%
C317	1	1	DF1515205	Film, 1500PF \pm 5%
C318	1	1	DF1515205	Film, 1500PF \pm 5%
C319	1	1	DF1522205	Film, 2200PF \pm 5%
C320	1	1	DF1522205	Film, 2200PF \pm 5%
C321	1	1	DF1510205	Film, 1000PF \pm 5%
C322	1	1	DF1510205	Film, 1000PF \pm 5%
C323	1	1	EV2240351	Electroly, 0.22 μ F \pm 20%,35V
C324	1	1	EV2240351	Electroly, 0.22 μ F \pm 20%,35V
C325	1	1	EV1050352	Electroly, 1 μ F \pm 20%,35V
C326	1	1	EV1050352	Electroly, 1 μ F \pm 20%,35V
C327	1	1	EA2270259	Electroly, 220 μ F, 25V
C328	1	1	EA2270169	Electroly, 220 μ F, 16V
C329	1	1	EA1060169	Electroly, 10 μ F, 16V

REF. DESIG.	U	E	PART NO.	DESCRIPTION
C330	1	1	DK1840302	Ceramic, 0.04 μ F +80%,-20%
C331	1	1	EA1050509	Electroly, 1 μ F, 50V
C332	1	1	EA1060169	Electroly, 10 μ F, 16V
C333	1	1	DD1210001	Ceramic, 10PF \pm 1PF
C334	1	1	DF1668301	Film, 0.068 μ F \pm 10%
C335	1	1	DF1740301	Film, 0.04 μ F \pm 20%
C336	1	1	DK1810402	Ceramic, 0.1 μ F +80%,-20%
C337	1	1	EA4750359	Electroly, 4.7 μ F, 35V
C338	1	1	EA1050509	Electroly, 1 μ F, 50V
C339	1	1	DK1840302	Ceramic, 0.04 μ F +80%,-20%
C340	1	1	DK1840302	Ceramic, 0.04 μ F +80%,-20%
C341	1	1	DK1840302	Ceramic, 0.04 μ F +80%,-20%
C343	1	1	DF1710402	Film, 0.1 μ F \pm 20%
C344	1	1	DK1820302	Ceramic, 0.02 μ F +80%,-20%
P300-SEMICONDUCTORS				
H301	1	1	HF200301C	FET, 2SK30Y
H302	1	1	HT308281D	Transistor, 2SC828S
H303	1	1	HT308281D	Transistor, 2SC828S
H304	1	1	HT307322A	Transistor, 2SC732B or G
H305	1	1	HT307322A	Transistor, 2SC732B or G
H306	1	1	HT104942A	Transistor, 2SA494 G or Y
H307	1	1	HT104942A	Transistor, 2SA494 G or Y
H308	1	1	HT308281D	Transistor, 2SC828S
H309	1	1	HT308281D	Transistor, 2SC828S
H310	1	1	HT308281D	Transistor, 2SC828S
H311	1	1	HT308281D	Transistor, 2SC828S
H312	1	1	HF200300A	FET, 2SK30A
H313	1	1	HT308281D	Transistor, 2SC828S
H314	1	1	HT308281D	Transistor, 2SC828S
H315	1	1	HT308281D	Transistor, 2SC828S
H316	1	1	HT308281D	Transistor, 2SC828S
H317	1	1	HT308281D	Transistor, 2SC828S
H318	1	1	HD1000105	Diode, IN60
H319	1	1	HD1000105	Diode, IN60
H321	1	1	HC1000401	IC, HA1156
P300-MISCELLANEOUS				
L301	1	1	LS1029004	MPX Coil, 56mH
L302	1	1	LS1029004	MPX Coil, 56mH
L303	1	1	LS1029005	MPX Coil, 43mH
L304	1	1	LS1029005	MPX Coil, 43mH
L305	1	1	LC2105001	Choke Coil, 1mH
J301	1	1	YP1000113	Plug
J302	1	1	YP1000113	Plug
J303	1	1	YP1000113	Plug
J304	1	1	YP1000113	Plug
J305	1	1	YP1000113	Plug
J306	1	1	YP1000113	Plug
J307	1	1	YP1000113	Plug
J308	1	1	YP1000113	Plug
J309	1	1	YP1000113	Plug
J310	1	1	YP1000113	Plug
J311	1	1	YP1000113	Plug
J312	1	1	YP1000113	Plug
J313	1	1	YP1000113	Plug
J314	1	1	YP1000113	Plug
J315	1	1	YP1000113	Plug
J316	1	1	YP1000113	Plug
J317	1	1	YP1000113	Plug
J318	1	1	YP1000113	Plug
J319	1	1	YP1000113	Plug
J320	1	1	YP1000113	Plug
J321	1	1	YP1000113	Plug

REF. DESIG.	U	E	PART NO.	DESCRIPTION
J322	1	1	YP1000113	Plug
DOLBY LEVEL CIRCUIT BOARD-PC01				
PC01	1	1	YD2916003	P. W. Board, Dolby Level (Print Only)
	1	1	ZZ2917203	P. W. Board Assembly
PC01-MISCELLANEOUS				
RC01	1	1	RA0104015	Trimming Resist, 100KΩ (B)
RC02	1	1	RA0104015	Trimming Resist, 100KΩ (B)
RC03	1	1	RT0568314	Resistor, 68KΩ ±5%, ¼W
RC04	1	1	RT0568314	Resistor, 68KΩ ±5%, ¼W
RC05	1	1	RT0510414	Resistor, 100KΩ ±5%, ¼W
RC06	1	1	RT0510414	Resistor, 100KΩ ±5%, ¼W
RC07	1	1	RT0539214	Resistor, 3.9KΩ ±5%, ¼W
RC08	1	1	RT0539214	Resistor, 3.9KΩ ±5%, ¼W
RC09	1	1	RT0510414	Resistor, 100KΩ ±5%, ¼W
RC10	1	1	RT0510414	Resistor, 100KΩ ±5%, ¼W
CC01	1	1	EV1050256	Electroly Cap., 1μF, 25V
CC02	1	1	EV1050256	Electroly Cap., 1μF, 25V
CC03	1	1	EV1050256	Electroly Cap., 1μF, 25V
CC04	1	1	EV1050256	Electroly Cap., 1μF, 25V
JC01	1	1	YP1000113	Plug
JC02	1	1	YP1000113	Plug
JC03	1	1	YP1000113	Plug
JC04	1	1	YP1000113	Plug
JC05	1	1	YP1000113	Plug
JC06	1	1	YP1000113	Plug
JC07	1	1	YP1000113	Plug
HC01	1	1	HT313272A	Transistor, 2SC1327 S or T
HC02	1	1	HT313272A	Transistor, 2SC1327 S or T
PHONO AMP. CIRCUIT BOARD-P400				
P400	1	1	YD2892008	P.W. Board, Phono Amp.(Print Only)
	1	1	ZZ2917108	P.W. Board Assembly
P400-RESISTORS				
All resistors are ±5% and ¼W, unless otherwise indicated.				
R401	1	1	RT0556314	56KΩ
R402	1	1	RT0556314	56KΩ
R403	1	1	RT0547114	470Ω
R404	1	1	RT0547114	470Ω
R405	1	1	RN0533314	33KΩ
R406	1	1	RN0510514	1MΩ
R407	1	1	RN0510514	1MΩ
R408	1	1	RA0104015	Trimming, 100KΩ (B) ±30%
R409	1	1	RA0104015	Trimming, 100KΩ (B) ±30%
R410	1	1	RN0527314	27KΩ
R411	1	1	RN0527314	27KΩ
R412	1	1	RT0562114	620Ω
R413	1	1	RT0562114	620Ω
R414	1	1	RT0522514	2.2MΩ
R415	1	1	RT0522514	2.2MΩ
R416	1	1	RN0522514	2.2MΩ
R417	1	1	RN0522514	2.2MΩ
R418	1	1	RN0527414	270KΩ
R419	1	1	RN0527414	270KΩ
R420	1	1	RT0547314	47KΩ

REF. DESIG.	U	E	PART NO.	DESCRIPTION
R421	1	1	RT0547314	47KΩ
R422	1	1	RT0522214	2.2KΩ
R423	1	1	RT0522214	2.2KΩ
R424	1	1	RN0568414	680KΩ
R425	1	1	RN0568414	680KΩ
R426	1	1	RN0510414	100KΩ
R427	1	1	RN0510414	100KΩ
R428	1	1	RN0547314	47KΩ
R429	1	1	RN0547314	47KΩ
R430	1	1	RT0547014	47Ω
R431	1	1	RT0547014	47Ω
R432	1	1	RN0533214	3.3KΩ
R433	1	1	RN0533214	3.3KΩ
R434	1	1	RT0510114	100Ω
R435	1	1	RT0547014	47Ω
R436	1	1	RT0547014	47Ω
P400-CAPACITORS				
C401	1	1	EV1050256	Electroly, 1μF ±20%, 25V
C402	1	1	EV1050256	Electroly, 1μF ±20%, 25V
C403	1	1	EE4760163	Electroly, 47μF ±20%, 16V
C404	1	1	EE4760163	Electroly, 47μF ±20%, 16V
C405	1	1	DD1540004	Ceramic, 40PF ±5%, 50V
C406	1	1	DD1540004	Ceramic, 40PF ±5%, 50V
C407	1	1	DD1104001	Ceramic, 4PF ±0.5PF, 50V
C408	1	1	DD1104001	Ceramic, 4PF ±0.5PF, 50V
C409	1	1	DF6556201	Film, 5600μF ±5%, 50V
C410	1	1	DF6556201	Film, 5600μF ±5%, 50V
C411	1	1	DF6516201	Film, 1600PF ±5%, 50V
C412	1	1	DF6516201	Film, 1600PF ±5%, 50V
C413	1	1	ED1070351	Electroly, 100μF, 35V
C414	1	1	DF1710551	Film, 1μF ±20%, 250V
C415	1	1	DF1710551	Film, 1μF ±20%, 250V
C416	1	1	DD1650001	Ceramic, 50PF ±10%, 250V
C417	1	1	DD1650001	Ceramic, 50PF ±10%, 250V
P400-SEMICONDUCTORS				
H401	1	1	HT313441E	Transistor, 2SC1344E
H402	1	1	HT313441E	Transistor, 2SC1344E
H403	1	1	HT313442A	Transistor, 2SC1344 D or E
H404	1	1	HT313442A	Transistor, 2SC1344 D or E
H405	1	1	HT304580R	Transistor, 2SC458L B
H406	1	1	HT304580R	Transistor, 2SC458L B
H407	1	1	HD2000121	Diode, 1S-2473C Ye
H408	1	1	HD2000121	Diode, 1S-2473C Ye
H409	1	1	HV0000206	Varistor, VD1212
P400-PLUGS				
J401	1	1	YP1000113	
J402	1	1	YP1000113	
J403	1	1	YP1000113	
J404	1	1	YP1000113	
J405	1	1	YP1000113	
J406	1	1	YP1000113	
J407	1	1	YP1000113	
J408	1	1	YP1000113	
P700-MISCELLANEOUS				
2012	8	8	51100306S	B.H.M. Screw B 3 x 6
2013	1	1	291710901	Shield
2014	2	2	51570306B	P. H. Tapt Screw P 3 x 6 ST
2018	2	2	51100310S	B.H.M. Screw B 3 x 10
2019	2	2	54040302N	Spring Washer
2020	2	2	53110303E	Hexagon Nut

U U.S.A.
E Europe

REF. DESIG.	U	E	PART NO.	DESCRIPTION	REF. DESIG.	U	E	PART NO.	DESCRIPTION
P700	2	2	YD2917003	MAIN AMP. CIRCUIT BOARD-P700	C711	2	2	DF1710452	Film, 0.1μF ±20%, 200V
	2	2	ZZ2917003	P.W.Board, Main Amp. (Print Only) P.W.Board Assembly	C712	2	2	DF1710452	Film, 0.1μF ±20%, 200V
				P700-RESISTORS	C713	2	2	DD1647050	Ceramic, 47PF ±10%, 500V
				All resistors are ±5% and ¼W, unless otherwise indicated.	C714	2	2	DD1647050	Ceramic, 47PF ±10%, 500V
R701	2	2	RT0547414	470KΩ	C715	2	2	DK1720301	Ceramic, 0.02μF ±20%, 50V
R702	2	2	RT0510214	1KΩ	C716	2	2	DK1720301	Ceramic, 0.02μF ±20%, 50V
R703	2	2	RT0510414	100KΩ	C717	2	2	DF1710405	Film, 0.1μF ±20%, 50V
R704	2	2	RT0515114	150Ω	C718	2	2	DF1710405	Film, 0.1μF ±20%, 50V
R705	2	2	RT0515314	15KΩ	C719	2	2	DF1710405	Film, 0.1μF ±20%, 50V
R706	2	2	RT0539214	3.9KΩ	C720	2	2	DF1710351	Film, 0.01μF ±20%, 200V
R707	2	2	RT0510314	10KΩ	C721	2	2	DK1650150	Ceramic, 500PF ±10%, 500V
R708	2	2	RT0510314	10KΩ	L701	2	2	LC2202001	Choke Coil, 2μH
R709	2	2	RT0510214	1KΩ					P700-SEMICONDUCTORS & PLUGS
R710	2	2	RT0522414	220KΩ	H701	1	1	HT313271T	Transistor, 2SC1327 T.U
					H702	1	1	HT313271T	Transistor, 2SC1327 T.U
R711	2	2	RT0543214	4.3KΩ	H703	2	2	HT107212A	Transistor, 2SA721 S.T
R712	2	2	RT0513314	13KΩ	H704	2	2	HT313272A	Transistor, 2SC1327 S.T
R713	2	2	RT0512214	1.2KΩ	H705	2	2	HT309452A	Transistor, 2SC945 Q.R
R714	2	2	RT0510114	100Ω	H706	2	2	HT107332A	Transistor, 2SA733 P.Q
R715	2	2	RT0556014	56Ω	H707	2	2	HT309452A	Transistor, 2S945 Q.R
R716	2	2	GJ0515201	1.5KΩ ±5%, 1W	H708	2	2	HT107332A	Transistor, 2SA733 P.Q
R717	2	2	GJ0515201	1.5KΩ ±5%, 1W	H709	2	2	HT304961B	Transistor, 2SC496 O
R718	2	2	RT0568114	680Ω	H710	2	2	HV0000705	Varistor, S3016R
R719	2	2	RT0568114	680Ω					
R720	2	2	RT0530114	300Ω	H711	1	1	HT107941Q	Transistor, 2SA794 Q.R
					H712	1	1	HT315671Q	Transistor, 2SC1567 Q.R
R721	2	2	RT0527314	27KΩ	H713	1	1	HT403821M	Transistor, 2SD382 M.L.K
R722	2	2	RT0527314	27KΩ	H714	1	1	HT205371M	Transistor, 2SB537 M.L.K
R723	2	2	RT0510414	100KΩ	H715	2	2	HD3002509	Diode, WZ-150(15V±5%)
R724	2	2	RT0547314	47KΩ	H716	2	2	HD3002509	Diode, WZ-150(15V±5%)
R725	2	2	RT0510114	100Ω	H718	2	2	HD2000321	Diode, 1S2471 (Black)
R726	2	2	RT0510114	100Ω	H719	2	2	HD2000321	Diode, 1S2471 (Black)
R727	2	2	RT0502214	2.2Ω	H720	2	2	HV0000506	Diode, VD1122
R728	2	2	RC0000012	0Ω	H721	2	2	HV0000506	Diode, VD1122
R729	2	2	RT0510214	1KΩ					
R730	2	2	RT0533214	3.3KΩ	J701	2	2	YP1000109	Plug
					J702	2	2	YP1000109	Plug
R731	2	2	RT0533214	3.3KΩ	J703	2	2	YP1000113	Plug
R732	2	2	RT0515114	150Ω	J704	2	2	YP1000113	Plug
R733	2	2	RT0513114	130Ω	J705	2	2	YP1000113	Plug
R734	2	2	GF0510112	100Ω ±5%, ½W	J706	2	2	YP1000113	Plug
R735	2	2	GF0510112	100Ω ±5%, ½W	J707	2	2	YP1000113	Plug
R736	2	2	RT0510114	100Ω	J708	2	2	YP1000113	Plug
R737	2	2	RT0510114	100Ω	J709	2	2	YP0600031	Plug, 5P Connector
R738	2	2	GJ0502202	2.2Ω ±5%, 2W	J710	2	2	YP0600030	Plug, 3P Connector
R739	2	2	GJ0510002	10Ω ±5%, 2W					
R740	2	2	BW1000205	0.2+0.2Ω, 5W					P700-MISCELLANEOUS
					2017	2	2	291726701	Heat Sink
R741	2	2	RA0202013	Trimming, 2KΩ (B)	2021	2	2	51100310E	B.H.M. Screw B 3x10
R742	2	2	RA0102020	Trimming, 1KΩ (B)	2022	2	2	54040302N	Spring Washer
R743	2	2	RC0000012	0Ω	2023	2	2	53110303E	Hexagon Nut
R744	2	2	RC0000012	0Ω	2024	2	2	53110301E	Hexagon Nut
R745	2	2	RT0556114	560Ω	2025	2	2	54020301E	Flat Washer P
R746	2	2	RC0000012	0Ω	2026	4	4	291726702	Heat Sink
					2027	4	4	51100308S	B. H. M. Screw B 3x8
					2028	4	4	53110303E	Hexagon Nut
					2103	4	4	281826703	Heat Sink
				P700-CAPACITORS & COIL	2104	8	8	51100310E	B.H.M. Screw B 3 x 10
C701	2	2	DF2710550	Film, 1μF ±20%, 100V	2105	8	8	53110303E	Hexagon Nut
C702	2	2	EE4760163	Electroly, 47μF ±20%, 16V	2106	8	8	54060300R	T.L. Washer IR
C703	2	2	EA1060169	Electroly, 10μF +50%,-0%, 16V	2107	8	8	53110301E	Hexagon Nut
C704	2	2	EA1060169	Electroly, 10μF +50%,-0%, 16V	2108	8	8	54040302N	Spring Washer
C705	2	2	DD1510101	Ceramic, 100PF ±5%, 50V	2111	2	2	281910101	Support
C706	2	2	DK1610201	Ceramic, 1000PF ±10%, 50V	2112	2	2	291705501	Collor
C707	2	2	DK1622151	Ceramic, 220PF ±10%, 500V	2113	2	2	59110339H	Washer
C708	2	2	DD1105050	Ceramic, 5PF ±0.25PF, 500V	2114	2	2	257700501	Clamper
C709	2	2	DD1515150	Ceramic, 150PF ±5%, 500V	2115	2	2	51100325E	B.H.M.Screw B 3x25
C710	2	2	DF1710452	Film, 0.1μF ±20%, 200V					

REF. DESIG.	U	E	PART NO.	DESCRIPTION
GENERAL MISCELLANEOUS				
2003	2	2	281826701	Heat Sink
2005	4	4	291716005	Bracket
2006	12	12	51380306T	P.H.Tapt Screw P 3x6ST
2010	4	4	291716003	Bracket
2011	8	8	51060406S	P.H.M. Screw P 4x6
2015	8	8	51100312E	B.H.M. Screw B 3x12
2032	4	4	257711802	Spacer
H001	1	1	HL001019A	Transistor, SJ2518
H002	1	1	HL001019A	Transistor, SJ2517
H003	1	1	HL001019A	Transistor, SJ2518
H004	1	1	HL001019A	Transistor, SJ2517
J012	1	1	YJ0500019	Socket, Power Transistor
J013	1	1	YJ0500019	Socket, Power Transistor
J014	1	1	YJ0500019	Socket, Power Transistor
J015	1	1	YJ0500019	Socket, Power Transistor
POWER SUPPLY CIRCUIT BOARD-P800				
P800	1	1	YD2916002	P.W. Board, Power Supply (Print Only)
	1	1	ZZ2917102	P.W. Board Assembly
P800-RESISTORS				
R801	1	1	GF0533014	33Ω ±5%, ¼W
R802	1	1	RT0547214	4.7KΩ ±5%, ¼W
R803	1	1	RT0547214	4.7KΩ ±5%, ¼W
R804	1	1	RT0539214	3.9KΩ ±5%, ¼W
R805	1	1	RT0522314	22KΩ ±5%, ¼W
R806	1	1	RA0502023	Trimming, 5KΩ (B)
R807	1	1	GS1015105	150Ω ±10%, 5W
R808	1	1	RT0533214	3.3KΩ ±5%, ¼W
R809	1	1	RT0510014	10Ω ±5%, ¼W
R810	1	1	RT0533314	33KΩ ±5%, ¼W
R811	1	1	RT0527314	27KΩ ±5%, ¼W
R812	1	1	RT0568214	6.8KΩ ±5%, ¼W
R813	1	1	RT0524414	240KΩ ±5%, ¼W
R814	1	1	RT0539314	39KΩ ±5%, ¼W
R815	1	1	GJ0556101	560Ω ±5%, 1W
R816	1	1	GU0556212	5.6KΩ ±5%, ½W
R817	1	1	GU0556212	5.6KΩ ±5%, ½W
R818	1	1	RT0556214	5.6KΩ ±5%, ¼W
P800-CAPACITORS				
C801	1	1	EA2270631	Electroly, 220μF, 63V
C802	1	1	EA1070509	Electroly, 100μF, 50V
C803	1	1	DF1710305	Film, 0.01μF, 50V
C804	1	1	EA2260359	Electroly, 22μF, 35V
C805	1	1	EA3370509	Electroly, 330μF, 50V
C806	1	1	EA4770169	Electroly, 470μF, 16V
C807	1	1	EA1060509	Electroly, 10μF, 50V
C808	1	1	EA4760169	Electroly, 47μF, 16V
C809	1	1	EA2270109	Electroly, 220μF, 10V
C810	1	1	DK1810351	Ceramic, 0.01μF, 500V
P800-SEMICONDUCTORS, RELAY & PLUGS				
H801	1	1	HT403302A	Transistor, 2SD330 D.E
H802	1	1	HT313183A	Transistor, 2SC1318 Q.R.P
H803	1	1	HT309452A	Transistor, 2SC945 Q.R
H804	1	1	HT403314A	Transistor, 2SD331 C.D.E.F
H805	1	1	HT309452A	Transistor, 2SC945 Q.R
H806	1	1	HT313183A	Transistor, 2SC1318 P.Q.R.
H807	1	1	HT313183A	Transistor, 2SC1318 P.Q.R
H808	1	1	HD2001103	Diode, DS131-B

REF. DESIG.	U	E	PART NO.	DESCRIPTION
H809	1	1	HD3002309	Diode, WZ-071
H810	1	1	HD3002709	Diode, WZ-140
H811	1	1	HD2001103	Diode, DS131-B
H812	1	1	HD2000321	Diode, 1S2471
L801	1	1	LY2024006	Relay, MY2, 24V
J801	1	1	YP1000113	Plug
J802	1	1	YP1000113	Plug
J803	1	1	YP1000113	Plug
J804	1	1	YP1000113	Plug
J805	1	1	YP1000113	Plug
J806	1	1	YP1000113	Plug
J807	1	1	YP1000113	Plug
J808	1	1	YP1000113	Plug
J809	1	1	YP1000113	Plug
J810	1	1	YP1000113	Plug
P800-MISCELLANEOUS				
2203	1	1	291626702	Heat Sink
2204	2	2	51102606S	B.H.M. Screw B 2.6x6
2205	1	1	51100310E	B.H.M. Screw B 3x10
2206	1	1	53110301E	Hexagon Nut
2207	1	1	54050300R	T.L.Washer OR
GENERAL MISCELLANEOUS				
0803	1	1	291516050	Bracket K
0810	1	1	291512002	Insulator
0811	2	2	51100306A	B.H.M. Screw B 3x6
0813	4	4	51100306A	B.H.M. Screw B 3x6
0817	2	2	51100306A	B.H.M. Screw B 3x6
0822	2	2	51100306A	B.H.M. Screw B 3x6
0827	2	2	51470306A	B.H.M. Screw B 3x6
0833	3	3	51100305A	B.H.M. Screw B 3x5
0834	1	1	291712001	Insulator
0835	2	2	291612001	Insulator
0903	1	1	281816003	Bracket
0904	1	1	281816004	Bracket
0905	4	4	51100406A	B.H.M. Screw B 4x6
1010	2	2	51042608A	F.H.M. Screw F 2.6x8
1111	2	2	51570306B	P.H.Tapt Screw P 3x6ST
1112	2	2	54050300R	T.L.Washer OR
1115	2	2	288610701	Sheet
1403	1	1	257710602	Bearing
1404	1	1	141511801	Spacer
1405	2	2	51040306A	F.H.M. Screw F 3x6
1608	1	1	285326901	Protector
1609	2	2	51570305B	P.H.Tapt Screw P 3x5ST
1615	2	2	287105302	Cover
1622	1	1	288612201	Sticker
M001	1	1	IM1104201	DC Meter, Signal Strength/Multipath
M002	1	1	IM1104202	DC Meter, FM Tuning
C008	1	1	EA3360109	Electroly Cap., 33μF±50%,-10%, 10V
PRE/TONE AMP. CIRCUIT BOARD-PE01				
PE01	1	1	YD2917002	P.W. Board, Pre/Tone Amp. (Print Only)
	1	1	ZZ2917002	P.W. Board Assembly

U U.S.A.
E Europe

REF. DESIG.	U	E	PART NO.	DESCRIPTION	REF. DESIG.	U	E	PART NO.	DESCRIPTION
PE01-RESISTORS					PE01-CAPACITORS				
All resistors are $\pm 5\%$ and $\frac{1}{4}W$, unless otherwise indicated.					Film, $1\mu F$ $\pm 20\%$, 250V				
RE02	1	1	RD0204001	Variable, 200K Ω (B)	CE05	1	1	DF1710552	Film, $1\mu F$ $\pm 20\%$, 250V
RE03	1	1	RD0204001	Variable, 200K Ω (B)	CE06	1	1	DF1710552	Film, $1\mu F$ $\pm 20\%$, 250V
RE04	1	1	RD0204001	Variable, 200K Ω (B)	CE07	1	1	DD1530001	Ceramic, 30PF $\pm 5\%$, 50V
RE09	1	1	RT0539114	390 Ω	CE08	1	1	DD1530001	Ceramic, 30PF $\pm 5\%$, 50V
RE10	1	1	RT0539114	390 Ω	CE09	1	1	EA1070109	Electroly, 100 μF $+50\%$, -10% , 10V
RE11	1	1	RN0510514	1M Ω	CE10	1	1	EA1070109	Electroly, 100 μF $+50\%$, -10% , 10V
RE12	1	1	RN0510514	1M Ω	CE11	1	1	EA1060359	Electroly, 10 μF , 35V
RE13	1	1	RN0547414	470K Ω	CE12	1	1	EA1060359	Electroly, 10 μF , 35V
RE14	1	1	RN0547414	470K Ω	CE13	1	1	EV3350356	Electroly, 3.3 μF $\pm 20\%$, 35V
RE15	1	1	RT0510214	1K Ω	CE14	1	1	EV3350356	Electroly, 3.3 μF $\pm 20\%$, 35V
RE16	1	1	RT0510214	1K Ω	CE15	1	1	DF1582205	Film, 0.0082 μF $\pm 5\%$, 50V
RE17	1	1	RT0551214	5.1K Ω	CE16	1	1	DF1582205	Film, 0.0082 μF $\pm 5\%$, 50V
RE18	1	1	RT0551214	5.1K Ω	CE17	1	1	DF1582205	Film, 0.0082 μF $\pm 5\%$, 50V
RE19	1	1	RT0522414	220K Ω	CE18	1	1	DF1582205	Film, 0.0082 μF $\pm 5\%$, 50V
RE20	1	1	RT0522414	220K Ω	CE19	1	1	DF1582205	Film, 0.0082 μF $\pm 5\%$, 50V
RE21	1	1	RC0000012	0 Ω	CE20	1	1	DF1582205	Film, 0.0082 μF $\pm 5\%$, 50V
RE22	1	1	RC0000012	0 Ω	CE21	1	1	DF1582205	Film, 0.0082 μF $\pm 5\%$, 50V
RE23	1	1	RT0527314	27K Ω	CE22	1	1	DF1582205	Film, 0.0082 μF $\pm 5\%$, 50V
RE24	1	1	RT0527314	27K Ω	CE23	1	1	DF1668205	Film, 0.0068 μF $\pm 10\%$, 50V
RE25	1	1	RT0527314	27K Ω	CE24	1	1	DF1668205	Film, 0.0068 μF $\pm 10\%$, 50V
RE26	1	1	RT0527314	27K Ω	CE25	1	1	DK1668101	Ceramic, 680PF $\pm 10\%$, 50V
RE29	1	1	RT0527314	27K Ω	CE26	1	1	DK1668101	Ceramic, 680PF $\pm 10\%$, 50V
RE30	1	1	RT0527314	27K Ω	CE27	1	1	DK1668101	Ceramic, 680PF $\pm 10\%$, 50V
RE31	1	1	RT0520314	20K Ω	CE28	1	1	DK1668101	Ceramic, 680PF $\pm 10\%$, 50V
RE32	1	1	RT0520314	20K Ω	CE29	1	1	DF1633205	Film, 0.0033 μF $\pm 10\%$, 50V
RE33	1	1	RT0510314	10K Ω	CE30	1	1	DF1633205	Film, 0.0033 μF $\pm 10\%$, 50V
RE34	1	1	RT0510314	10K Ω	CE31	1	1	DD1650001	Ceramic, 50PF $\pm 10\%$, 50V
RE35	1	1	RT0510314	10K Ω	CE32	1	1	DD1650001	Ceramic, 50PF $\pm 10\%$, 50V
RE36	1	1	RT0510314	10K Ω	CE33	1	1	EV1050256	Electroly, 1 μF $\pm 20\%$, 25V
RE37	1	1	RT0510314	10K Ω	CE34	1	1	EV1050256	Electroly, 1 μF $\pm 20\%$, 25V
RE38	1	1	RT0510314	10K Ω	CE35	1	1	EV3350356	Electroly, 3.3 μF $\pm 20\%$, 35V
RE39	1	1	RT0510314	10K Ω	CE36	1	1	EV3350356	Electroly, 3.3 μF $\pm 20\%$, 35V
RE40	1	1	RT0510314	10K Ω	CE37	1	1	EQ4750161	Electroly, 4.7 μF $\pm 30\%$, 16V
RE41	1	1	RT0547414	470K Ω	CE38	1	1	EQ4750161	Electroly, 4.7 μF $\pm 30\%$, 16V
RE42	1	1	RT0547414	470K Ω	CE39	1	1	EA2270359	Electroly, 220 μF $+5\%$, -10% , 35V
RE43	1	1	RC0000012	0 Ω	PE01-SEMICONDUCTORS, PLUG & SWITCH				
RE44	1	1	RC0000012	0 Ω	HE01	1	1	HC1000121	IC, BA312
RE45	1	1	RT0522514	2.2M Ω	HE02	1	1	HC1000121	IC, BA312
RE46	1	1	RT0522514	2.2M Ω	HE03	1	1	HT313272A	Transistor, 2SC1327 S.T.
RE47	1	1	RT0522514	2.2M Ω	HE04	1	1	HT107212A	Transistor, 2SA721 S.T.
RE48	1	1	RT0522514	2.2M Ω	HE05	1	1	HT313272A	Transistor, 2SC1327 S.T.
RE49	1	1	RT0522514	2.2M Ω	HE06	1	1	HT107212A	Transistor, 2SA721 S.T.
RE50	1	1	RT0522514	2.2M Ω	JE01	1	1	YP0600028	Plug
RE51	1	1	RT0510314	10K Ω	SE01	1	1	SR1005007	Rotary Switch, Tone Mode
RE52	1	1	RT0510314	10K Ω	DOLBY-FM, TAPE MON. CIRCUIT BOARD-PS01				
RE53	1	1	RT0510314	10K Ω	PS01	1	1	YD2917004	P.W. Board, Dolby FM, Tape Mon. (Print Only)
RE54	1	1	RT0510314	10K Ω				ZZ2917004	P.W. Board Assembly
RE55	1	1	RT0510314	10K Ω				ZZ2917804	P.W. Board Assembly
RE56	1	1	RT0510314	10K Ω					
RE57	1	1	RC0000012	0 Ω					
RE58	1	1	RC0000012	0 Ω					
RE59	1	1	RC0000012	0 Ω					
RE60	1	1	RC0000012	0 Ω					
RE61	1	1	RT0527214	2.7K Ω					
RE62	1	1	RT0510414	100K Ω					
RE63	1	1	RT0547414	470K Ω					
RE64	1	1	RT0547414	470K Ω					
RE65	1	1	RT0547314	47K Ω					
RE66	1	1	RT0547314	47K Ω					
RE67	1	1	RT0522114	220 Ω					

REF DESIG.	U	E	PART NO	DESCRIPTION
PS01-MISCELLANEOUS				
RS01	1	1	RT0510214	Resistor, 1KΩ ±5%, ¼W
RS02	1	1	RT0510214	Resistor, 1KΩ ±5%, ¼W
RS03	1	1	GJ0515101	Resistor, 150Ω ±5%, 1W
RS04	1	1	RT0510114	Resistor, 100Ω ±5%, ¼W
RS05	1	1	RT0522214	Resistor, 2.2KΩ ±5%, ¼W
RS06	1	1	RT0522214	Resistor, 2.2KΩ ±5%, ¼W
RS07	1	1	RT0556214	Resistor, 5.6KΩ ±5%, ¼W
RS08	1	1	RT0510314	Resistor, 10KΩ ±5%, ¼W
RS09	1	1	GD0522314	Resistor, 22KΩ ±5%, ¼W
RS10	1	1	RC0000012	Resistor, 0Ω
RS11	1	1	RC0000012	Resistor, 0Ω
RS12	1	1	RT0556014	Resistor, 56Ω ±5%, ¼W
SS01	1	1	SP0607001	Pushswitch, Dolby FM, Tape Mon
CS06	1	1	DF1510205	Film Cap., 1000PF ±5%, 50V
CS07	1	1	DF1510205	Film Cap., 1000PF ±5%, 50V
CS01	1	1	EA4750359	Electroly Cap., 4.7μF +50%,-10%,35V
CS02	1	1	EA4750359	Electroly Cap., 4.7μF +50%,-10%,35V
CS03	1	1	EA4750359	Electroly Cap., 4.7μF +50%,-10%,35V
CS04	1	1	EA1060169	Electroly Cap., 10μF 16V
CS05	1	1	EA1060169	Electroly Cap., 10μF, 16V
CS06	1	1	DF6520201	Film Cap., 2000PF ±5%, 50V
CS07	1	1	DF6520201	Film Cap., 2000PF ±5%, 50V
CS08	1	1	DF1615301	Film Cap., 0.015μF ±10%, 50V
CS09	1	1	DD1610101	Ceramic Cap., 100PF ±10%, 50V
HS01	1	1	HT309452A	Transistor, 2SC945 Q or R
HS02	1	1	HT309452A	Transistor, 2SC945 Q or R
HS03	1	1	HD1000105	Diode, IN60
HS04	1	1	HD1000105	Diode, IN60
JS01	1	1	YP1000113	Plug
JS27	1	1	YP1000113	Plug
FILTER, LOUDNESS CIRCUIT BOARD-PT01				
PT01	1	1	YD2917005	P.W. Board, Filter, Loudness (Print Only)
	1	1	ZZ2917005	P. W. Board Assembly
PT01-MISCELLANEOUS				
RT01	1	1	RT0510514	Resistor, 1MΩ ±5%, ¼W
RT02	1	1	RT0510514	Resistor, 1MΩ ±5%, ¼W
RT03	1	1	RT0510514	Resistor, 1MΩ ±5%, ¼W
RT04	1	1	RT0510514	Resistor, 1MΩ ±5%, ¼W
RT05	1	1	RT0547214	Resistor, 4.7KΩ ±5%, ¼W
RT06	1	1	RT0547214	Resistor, 4.7KΩ ±5%, ¼W
RT07	1	1	RT0547314	Resistor, 47KΩ ±5%, ¼W
RT08	1	1	RT0547314	Resistor, 47KΩ ±5%, ¼W
RT09	1	1	GJ0533102	Resistor, 330Ω ±5%, 2W
RT10	1	1	GJ0533102	Resistor, 330Ω ±5%, 2W
RT11	1	1	GJ0515101	Resistor, 150Ω ±5%, 1W
RT12	1	1	GJ0515101	Resistor, 150Ω ±5%, 1W
RT13	1	1	RT0515314	Resistor, 15KΩ ±5%, ¼W
RT14	1	1	RT0515314	Resistor, 15KΩ ±5%, ¼W
RT15	1	1	RT0510414	Resistor, 100KΩ ±5%, ¼W
RT16	1	1	RT0510414	Resistor, 100KΩ ±5%, ¼W
ST01	1	1	SP0407001	Pushswitch
CT01	1	1	DF1647301	Film Cap., 0.047μF ±10%, 50V
CT02	1	1	DF1647301	Film Cap., 0.047μF ±10%, 50V
CT03	1	1	DF1668205	Film Cap., 0.0068μF ±10%, 50V
CT04	1	1	DF1668205	Film Cap., 0.0068μF ±10%, 50V
CT05	1	1	DF1633301	Film Cap., 0.033μF ±10%, 50V
CT06	1	1	DF1633301	Film Cap., 0.033μF ±10%, 50V

REF. DESIG.	U	E	PART NO.	DESCRIPTION
CT07	1	1	DD1615101	Ceramic Cap., 150PF ±10%, 50V
CT08	1	1	DD1615101	Ceramic Cap., 150PF ±10%, 50V
JT01	1	1	YP1000113	Plug
JT21	1	1	YP1000113	Plug
GENERAL MISCELLANEOUS				
S001	1	1	SR1006014	Rotary Switch, Selector
J009	1	1	YJ0100081	Jack, Dubbing In
J010	1	1	YJ0100098	Jack, Dubbing Out
0821	1	1	291616002	Bracket
J011	1	1	YJ0100098	Jack, Headphone
0816	1	1	291716002	Bracket
R005	1	1	RH0254022	Variable Resist. 250KΩ (B)
J016	1	1	YJ0600019	Jack, Pre/Tone Amp.
R001	1	1	RS0254007	Variable Resist. 250KΩ (MN)
FUNCTION LAMP BOARD-PY01				
PY01	1	1	YD2916006	P.W. Board, Function Lamp (Print Only)
	1	1	ZZ2917106	P.W. Board Assembly
PY01- MISCELLANEOUS				
MY01	1	1	1N1008037	Lamp, 8V, 0.04A
MY08	1	1	1N1008037	Lamp, 8V, 0.04A
JY01	1	1	YP1000113	Plug
JY11	1	1	YP1000113	Plug
DIAL LAMP BOARD-PZ01				
PZ01	1	1	YD2886016	P.W. Board, Dial Lamp (Print Only)
	1	1	ZZ2917116	P.W. Board Assembly
PZ01-MISCELLANEOUS				
MZ01	1	1	1N1008036	Lamp, 8V, 0.2A
MZ05	1	1	1N1008036	Lamp, 8V, 0.2A
JZ01	1	1	YJ0800017	Socket
JZ10	1	1	YJ0800017	Socket
JZ11	1	1	YP1000113	Plug
JZ14	1	1	YP1000113	Plug
GENERAL MISCELLANEOUS				
0919	1	1	287127101	Holder, Dial Lamp
0920	2	2	51570306B	P.H. Tapt Screw P 3x6 ST
0917	1	1	287127401	Reflector
0922	1	1	288627101	Holder
0923	2	2	51570306B	P.H. Tapt Screw P 3x6 ST
0926	2	2	51100306A	B. H. M. Screw B 3x6
0927	2	2	51480306A	B. H. M. Screw B 3x6
M004	1	1	1N1008036	Lamp, Meter
M005	1	1	1N1008036	Lamp, Meter
J017	1	1	YJ0800019	Socket, Meter Lamp
J018	1	1	YJ0800019	Socket, Meter Lamp
1103	1	1	288627102	Holder, Lamp
1104	2	2	51570306B	P. H. Tapt Screw P 3 x 6 ST
1022	1	1	288627401	Reflector

U U.S.A.
E Europe

REF. DESIG.	U	E	PART NO.	DESCRIPTION	REF. DESIG.	U	E	PART NO.	DESCRIPTION
1026	1	1	288626251	Pulley K	JU01	1	1	YT0304007	Terminal, 4P (AM/FM Ant.)
1032	2	2	51100306A	B. H. M. Screw B 3x6	JU02	1	1	YP1000113	Plug
1033	2	2	54050300R	T. L. Washer OR	JU03	1	1	YP1000113	Plug
1107	2	2	51480306A	B. H. M. Screw B3 x 6	JU04	1	1	YP1000113	Plug
0934	1	1	287105102	Guide	JU05	1	1	YP1000113	Plug
1002	1	1	288626252	Pulley K	JU06	1	1	YP1000113	Plug
1007	2	2	51100305A	B. H. M. Screw B 3x5	JU07	1	1	YP1000113	Plug
1303	1	1	285310650	Bearing K	0605	1	1	291616005	Bracket
1308	1	1	51640410D	Set Screw C. P.	GENERAL MISCELLANEOUS				
1309	1	1	54040402N	Spring Washer	L001	1	1	LF1120038	Ant. Coil
1310	1	1	53110403E	Hexagon Nut	0705	1	1	281927103	Holder
0830	1	1	291512003	Insulator	0706	1	1	257816052	Bracket K
0831	1	1	291710903	Shield	0711	2	2	51100310S	B. H. M. Screw B 3 x 10
0832	1	1	288912005	Insulator	0712	2	2	54050300R	T. L. Washer OR
0503	1	1	291718001	Bracket	0713	2	2	53110303E	Hexagon Nut
0505	1	1	291716022	Bracket	0716	2	2	51100310S	B. H. M. Screw B 3 x 10
0513	1	1	145525903	Bush, AC Cord	0718	2	2	53110303E	Hexagon Nut
0514	1	1	284906702	Cap, AC Cord	R004	1	1	RC1022512	Resistor, 2.2M Ω \pm 10%, 1/2W
0516	1	1	282125901	Bush	9336	1	1	62030039W	Lug
0517	2	2	55060305S	T. R. Rivet	C003	1	1	DK1710301	Ceramic Cap., 0.01 μ F \pm 20%
0518	2	2	54050300R	T. L. Washer OR	0531	1	1	62041760W	Lug
0519	2	2	51060316A	P. H. M. Screw P 3 x 16	C010	1	1	DK1710301	Ceramic Cap., 0.01 μ F \pm 20%
0520	2	2	53110303A	Hexagon Nut	2705	1	1	62030039W	Lug
0523	4	4	51100308S	B. H. M. Screw B 3 x 8	H005	1	1	HD2001705	Diode, S5188
0524	4	4	53110303A	Hexagon Nut	2217	1	1	51100320E	B. H. M. Screw B 3 x 20
0525	4	4	54050300R	T. L. Washer OR	2218	1	1	53110301E	Hexagon Nut
0530	1	1	54050400R	T. L. Washer OR	2222	1	1	291726703	Heat Sink
0533	4	4	51100306S	B. H. M. Screw B 3 x 6	C004	1	1	DF1710452	Film Cap., 0.1 μ F \pm 20%, 200V
0534	4	4	53110303A	Hexagon Nut	C005	1	1	DF1710452	Film Cap., 0.1 μ F \pm 20%, 200V
0602	8	8	51100306S	B. H. M. Screw B 3x6	R002	1	1	GJ0522202	Resistor, 2.2K Ω \pm 5%, 2W
0603	8	8	53110303A	Hexagon Nut	R003	1	1	GJ0522202	Resistor, 2.2K Ω \pm 5%, 2W
0606	2	2	51100306S	B. H. M. Screw B 3 x 6	2225	2	2	62030039W	Lug
0616	1	1	145525903	Bush, Ferrite-rod Ant.	J023	1	1	YL0105011	Terminal, 5P
0620	3	3	51100306S	B. H. M. Screw B 3 x 6	C002	1	1	DK1710301	Ceramic Cap., 0.01 μ F \pm 20%
F001	1	1	FS1050004	Fuse, 5A MGC UL	L002	1	1	LC1332002	Choke Coil 3.3 μ H
G001	1	1	BF1040003	Printed Comp.	2713	1	1	287100501	Clamper
C009	1	1	DF1722380	Film Cap., 0.022 μ F \pm 20%,450V AC	2714	1	1	287100501	Clamper
W001	1	1	YC0240010	AC Cord, Power Supply	2805	2	2	287100501	Clamper
J002	1	1	YT0304008	Terminal, Main Spkr	1735	1	1	138200503	Clamper
J003	1	1	YT0304008	Terminal, Remote Spkr	1603	1	1	291730201	Dial
J004	1	1	YT0101003	Terminal, Ground	1606	1	1	285610701	Sheet
J005	1	1	YT0204008	Terminal, 4P(Phono, Aux.)	W009	1	1	YB0007001	Connective Cord
J006	1	1	YT0208006	Terminal, 8P (Tape 1, Tape 2)	W010	1	1	YB0007001	Connective Cord
J007	1	1	YT0204009	Terminal, 4P (w/Switch)	W011	1	1	YB0027001	Connective Cord
J008	1	1	YT0201009	Terminal, IP (Quadradial)	J022	1	1	YL0106004	Terminal, Voltage Conversion
J019	1	1	YJ0400048	Plug, AC Outlet	2503	1	1	289016008	Bracket
J020	1	1	YJ0400048	Plug, AC Outlet	2504	1	1	285412001	Insulator
J021	1	1	YJ0800012	Holder, Fuse	ANTENNA/MUTING BOARD-PU01				
PU01	1	1	YD2916007	P. W. Board, Ant. Muting(Print Only)	P. W. Board Assembly				
	1	1	ZZ2917107	P. W. Board Assembly	PU01-MISCELLANEOUS				
RU04	1	1	RK0203032	Trimming Resist. 20K Ω (B)					
RU05	1	1	RK0503010	Trimming Resist. 50K Ω (B)					
LU01	1	1	LB3007526	Balun Coil, 75 Ω \approx 300 Ω					
LU02	1	1	LC1154002	Choke Coil, 150 μ H					

REF. DESIG.	U	E	PART NO.	DESCRIPTION
2505	4		51100310A	B. H. M. Screw B 3 x 10
2506	5		54060300R	T. L. Washer 1R
FUSE BOARD-PR01				
PR01	1		YD2871003	P. W. Board, Fuse (Print Only)
	1		ZZ2871803	P. W. Board Assembly
PR01-MISCELLANEOUS				
JR01	1		YJ0800020	Jack
JR02	1		YJ0800020	Jack
JR03	1		YJ0800020	Jack
JR04	1		YJ0800020	Jack
JR05	1		YJ0800020	Jack
JR06	1		YJ0800020	Jack
JR07	1		YJ0800020	Jack
JR08	1		YJ0800020	Jack
JR09	1		YP1000099	Plug
JR10	1		YP1000099	Plug
JR11	1		YP1000099	Plug
JR12	1		YP1000099	Plug
JR13	1		YP1000099	Plug
JR14	1		YP1000099	Plug
JR15	1		YP1000099	Plug
JR16	1		YP1000099	Plug
2515	1		285416003	Bracket
2518	2		51100306S	B. H. M. Screw B 3x6
GENERAL MISCELLANEOUS				
0221	4	4	275905701	Leg
0222	4	4	51490410S	B. H. M. Screw F. S
0510	6	6	51100306S	B. H. M. Screw B 3 x 6
0907	10	10	51570306B	P. H. Tapt Screw P 3 x 6 ST
1830	4	4	51570306B	P. H. Tapt Screw P 3 x 6 ST
2008	8	8	51570306B	P. H. Tapt Screw P 3 x 6 ST
2120	1	1	291610903	Shield
2121	3	3	51570306B	P. H. Tapt Screw P 3 x 6 ST
2209	3	3	51100306S	B. H. M. Screw B 3 x 6
2210	1	1	51570306S	P. H. Tapt Screw P 3 x 6 ST
2214	4	4	51570406B	P. H. Tapt Screw P 4 x 6 ST
2215	1	1	291716004	Bracket
2216	1	1	51570406B	P. H. Tapt Screw P 4 x 6 ST
2219	1	1	54050400R	T. L. Washer OR
2223	2	2	51570308B	P. H. Tapt Screw P 3 x 8 ST
2224	1	1	54050300R	T. L. Washer OR
2228	4	4	51490512A	B. H. M. Screw FS
2229	4	4	53110501A	Hexagon Nut
2230	4	4	54020501A	Flat Washer P
2233	1	1	281805603	Buffer
2303	1	1	285610902	Shield
2304	4	4	285610102	Support
2305	1	1	281810107	Support
2306	5	5	51060304E	B. H. M. Screw P 3 x 4
2313	4	4	51100306S	B. H. M. Screw B 3 x 6
2323	2	2	288616011	Bracket
2324	2	2	288612009	Insulator
2325	4	4	51570306B	P. H. Tapt Screw P 3 x 6 ST
2403	4	4	288810102	Support
2413	2	2	288810102	Support
2414	2	2	51100306S	B. H. M. Screw B 3 x 6
2251	1	1	138200503	Clamper
2423	2	2	291610101	Support

REF. DESIG.	U	E	PART NO.	DESCRIPTION
2516	2		51570305B	P. H. Tapt Screw P 3 x 5 ST
2528	1	1	51570306B	P. H. Tapt Screw P 3 x 6 ST
2529	1	1	54050300R	T. L. Washer OR
2603	1	1	291710550	Chassis K
2616	6	6	288600502	Clamper
2618	4	4	288600504	Clamper
2621	2	2	285310102	Support
2622	2		54040402N	Spring Washer
2623	2	2	291616007	Bracket
2630	2	2	288925901	Bush
2707	3	3	51570306B	P. H. Tapt Screw P 3 x 6 ST
2710	1	1	121000501	Clamper
2711	1	1	54050300R	T. L. Washer OR
2718	1	1	62030039W	Lug
2719	1	1	51570306B	P. H. Tapt Screw P 3 x 6 ST
2721	1	1	62030039W	Lug
2722	1	1	51570306B	P. H. Tapt Screw P 3 x 6 ST
2806	2	2	51570305B	P. H. Tapt Screw P 3 x 5 ST
L003	1		TS6140105	Transformer
L003	1		TS6140106	Transformer
C006	1	1	EC1390551	Electroly Cap., 13mF +50%,-10%,55V
C007	1	1	EC1390551	Electroly Cap., 13mF +50%,-10%,55V
W001	1		YC0190003	AC Cord
J024	1	1	YJ0600031	Jack, 5P
J025	1	1	YJ0600042	Jack, 5P
J026	1	1	YJ0600030	Jack, 3P
J027	1	1	YJ0600032	Jack, 3P
FR01	1		FS1040006	Fuse, 4A
FR02	1		FS1010007	Fuse, 1A
FR03	1		FS1010007	Fuse, 1A
FR04	1		FS1040006	Fuse, 4A
0115	4	4	52017039J	Bolt
0120	1	1	291605501	Collar
0203	1	1	291625701	Lid
0204	5	5	257711807	Spacer
0205	4	4	285605601	Buffer
0206	1	1	291716006	Bracket
0207	4	4	51480406S	B. H. M. Screw F.
0208	2	2	291705601	Buffer
0213	1	1	291625702	Lid
0214	1	1	291512001	Insulator
0215	1		250712001	Insulator
0216	10	10	51100406S	B. H. M. Screw B 4 x 6
0304	1	1	285015401	Knob, Slide Volume
0305	14	14	288615403	Knob, Pushswitch
0307	3	3	281815403	Knob
0402	1		291726501	Indicator, Name Plate
0404	1		291726503	Indicator, Name Plate
0410	2	2	51100305S	B. H. M. Screw B 3 x 5
0411	1	1	257886101	Label, UL Caution
0412	1	1	257886102	Label, Do not remove cover.
0413	1	1	257886103	Label, See Marking on botton.
0414	1	1	250626506	Indicator, Do not use as handle.
0421	1		951091102	Label, Factory
0424	1		951110102	Label, UL
0430	1	1	288686101	Label, On Power Transf.
0819	1	1	289610701	Sheet
0823	2	2	289610701	Sheet
1410	1	1	285011202	Shaft

U U.S.A.
E Europe

REF. DESIG.	U	E	PART NO.	DESCRIPTION
1411	1	1	54040402N	Spring Washer
1612	1	1	291526901	Protector
1613	2	2	51570305B	P. H. Tapt Screw P 3 x 5 ST
1618	1	1	286726901	Protector
1619	2	2	51100305S	B. H. M. Screw B 3 x 5
1624	1	1	281912005	Insulator
1803	1	1	289010903	Shield
1804	4	4	289205601	Buffer
1823	2	2	51100305S	B. H. M. Screw B 3 x 5
1910	1	1	56382540G	Eyelet
2405	1	1	291610902	Shield
2406	4	4	51100304S	B. H. M. Screw B 3 x 4
2416	1	1	291610901	Shield
2417	2	2	51100304S	B. H. M. Screw B 3 x 4
2424	2	2	51100304S	B. H. M. Screw B 3 x 4
2902	1		291785101	Instructions, Set
2903	1	1	291785121	Instructions, Set
2909	1		291785601	Schematic Diagram
2910	1	1	291785602	Schematic Diagram
2914	1	1	281885108	Instructions, Accessories
2917	1	1	281885104	Instructions, Partitioner
2919	1	1	281885110	Instructions, 4 CH
2924	1	1	257785401	Guarantee Card
2925	1	1	257785102	Instructions
2926	1		257781301	Envelope
2931		1	281881301	Envelope
3002	1	1	291780101	Packing Case
3003	1	1	291780111	Packing Case
3008	1	1	288680302	Partitioner, Upper
3009	1	1	288680303	Partitioner, Lower
3012	1	1	901483838	Polyethylen Bag, Set
3014	1	1	901302501	Polyethylen Bag, Printed Matter
3015	1	1	901302501	Polyethylen Bag, Accessories
3017	1	1	102980401	Sleeve, AC Cord
3018		1	956000004	Hang Tag, Voltage Conversion
3019	2	2	273182101	Silicagel
3020	1	1	281905601	Buffer
3022	4		952281501	Serial NO. Card
3024		4	952301511	Serial NO. Card
3031	1	1	ZA0200007	Ext. Antenna, FM
			291785501	Service Manual

TECHNICAL SPECIFICATIONS

PRE AMPLIFIER SECTION

Phono Dynamic Range	98dB
Note: Dynamic Range is the ratio in dB of phono overload (115mV) to equivalent input noise (1.45μV).	
Input Sensitivity and Impedance	Phono: 1.8mV, 47K ohms High Level: 180mV, 50K ohms
Pre-Out Level	1V
Pre-Out Output Impedance	900 ohms
Phono Frequency Response	±1dB, 30Hz to 15kHz (to RIAA curve)
Signal/Noise-Aux	-82dB
Tone Controls	Treble: ±12dB at 15kHz Bass: ±12dB at 50Hz
Filters	Hi Filter: 5kHz, 6dB/Octave low Filter: 100Hz, 6dB/Octave
Loudness Compensation	100Hz, +8dB 10kHz, +5dB

AMPLIFIER SECTION

Headphones Output	0.5V(referenced to Rated Power Output)
Input Sensitivity for MAIN IN Front/Rear	1V for Rated Power Output
Rated Power Output (Continuous average power per channel, all channels driven)	
Power Output	75 Watts, 4 ohms 75 Watts, 8 ohms 40 Watts, 16 ohms
Power Band	20Hz to 20kHz
THD	0.25%
Frequency Response	±1dB, 20Hz to 20kHz
Damping Factor	60

FM SECTION

Quieting Slope	1.9μV: 30 dB Quieting 5μV: 35dB Quieting 10μV: 60dB Quieting 50μV: 70dB Quieting 1000μV: 70dB Quieting
Ultimate Quieting	1000μV: 70dB Quieting
Selectivity (Alternate Channel)	80dB
Capture Ratio	1.5dB
Muting Threshold	Variable, 7μV to 70μV
Stereo Separation	42dB at 1 kHz
Total Harmonic Distortion	Mono: 0.25% Stereo: 0.35%
Frequency Response	±1.0dB, 30Hz to 15 kHz
Total Spurious Rejection	Greater than 100dB
Image Rejection	Greater than 100dB
AM Suppression	Greater than 60dB
IF Rejection	Greater than 100dB
Antenna Impedance	75 or 300 ohms
Quadradial Output	340mV for 100% Modulation

AM SECTION

AM Sensitivity	20 μ V
Selectivity	± 20 kHz >45dB
AM Bandwidth	-6dB, 7kHz
Image Rejection	Greater than 60 dB

GENERAL

Power Requirements	220V~50/60 Hz
(This unit can be converted by a qualified technician to operate on 110/120/240V~50/60Hz.)	
Unit Dimensions	Height: 5-3/8" (without feet)
Dimensions – Panel Width	17-5/16"-439mm
– Panel Height	5-3/8"-137mm
– Depth	14-3/8"-366mm
Weight – Unit alone	37.9 lbs-17.7 Kg
– Packed for Shipment	45.1 lbs-20.5 Kg

* These specifications and exterior designs may be changed for improvement without advance notice.

SERVICE INFORMATION FOR EUROPEAN MODEL

The information contained here in included the fuse assembly PR01, rear panel and main chassis component locations, voltage conversion, FTZ regulation, and schematic diagram.

For the circuit description, alignment method and repairing hints, refer to the original service manual.

TABLE OF CONTENTS

Fuse Assembly PR01 Component Locations	35
Rear Panel Jacks and Component Locations	36
Main Chassis Component Locations (Bottom View)	36
Voltage Conversion	37
Voltage Conversion Chart	37
FTZ Regulation	37
Schematic Diagram	39

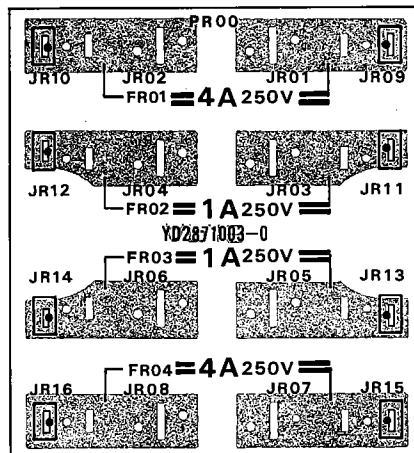

Figure 22. Fuse Assembly PR01 Component Locations

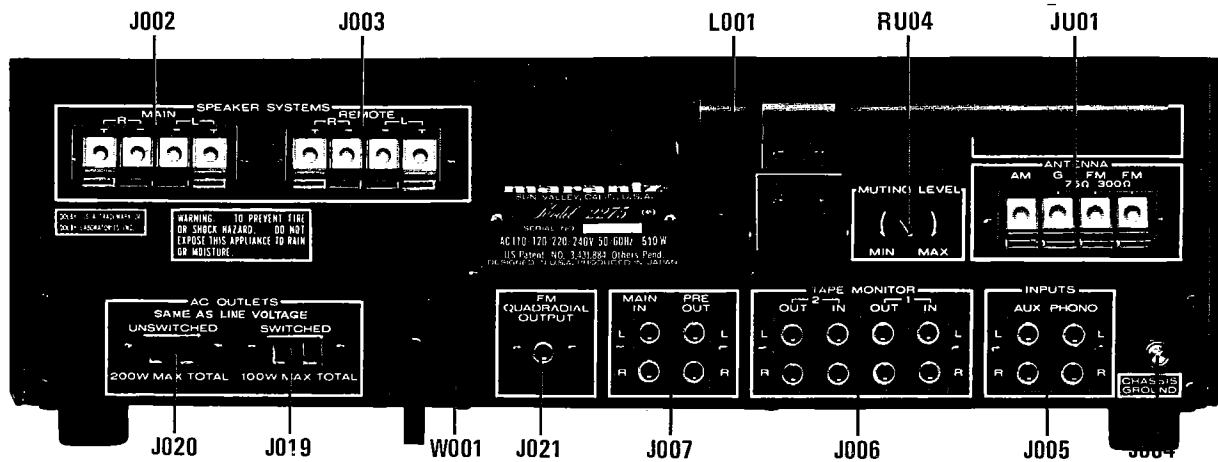

Figure 23. Rear Panel Jacks and Component Locations

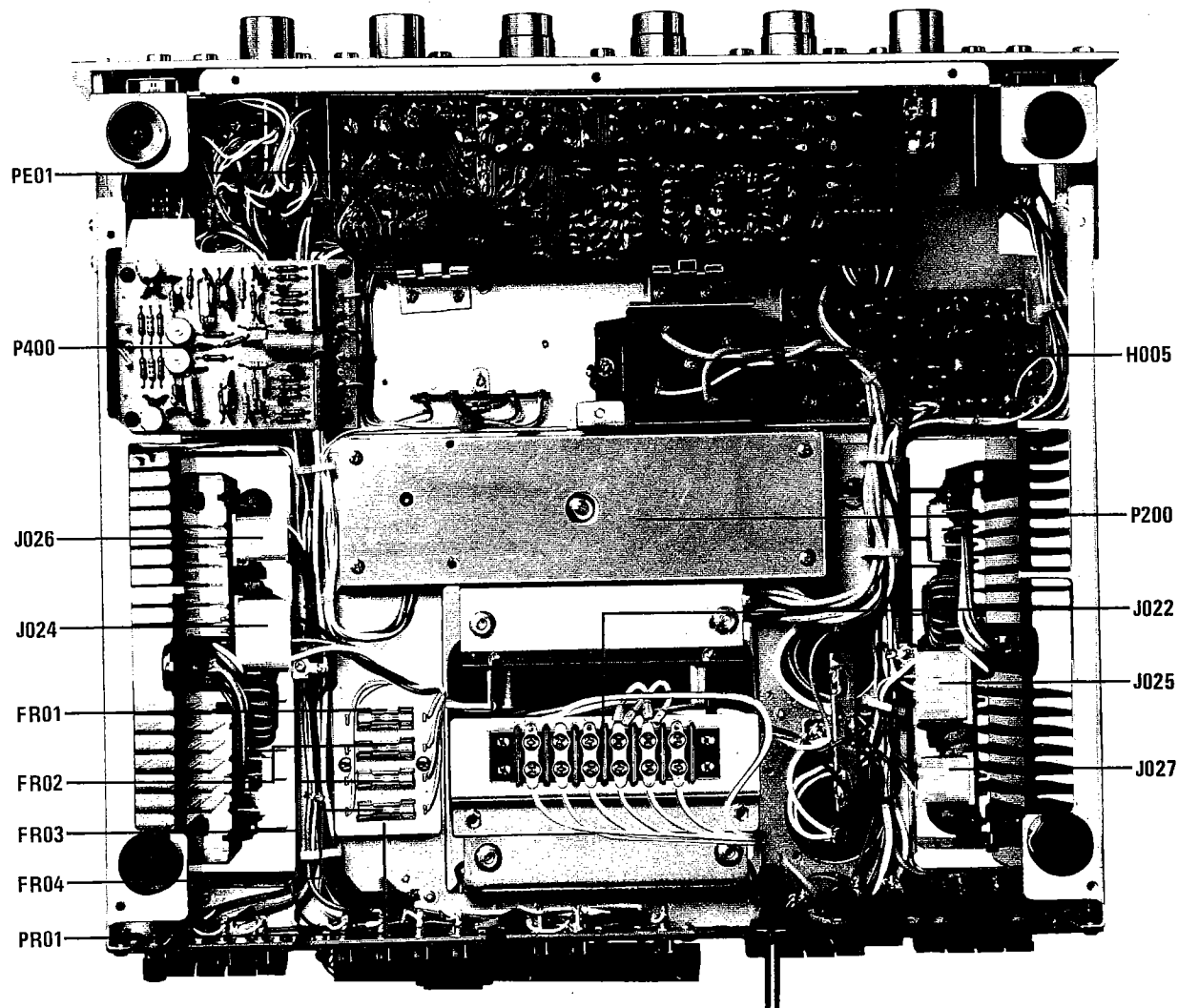

Figure 24. Main Chassis Component Locations (Bottom View)

VOLTAGE CONVERSION

This model is equipped with a universal power transformer to permit operation at 110, 120, 220

VOLTAGE CONVERSION

This model is equipped with a universal power transformer to permit operation at 110, 120, 220 and 240 V AC 50 to 60 Hz.

To convert the unit to the required voltage perform the following steps:

- (1) Remove the lid (top).
- (2) Change the jumper wires as illustrated below for the required AC voltage.

CAUTION: DISCONNECT POWER SUPPLY CORD FROM AC OUTLET BEFORE CONVERTING VOLTAGE.

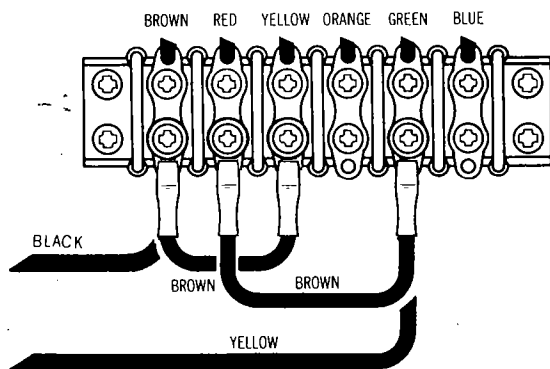

For 110V Operation

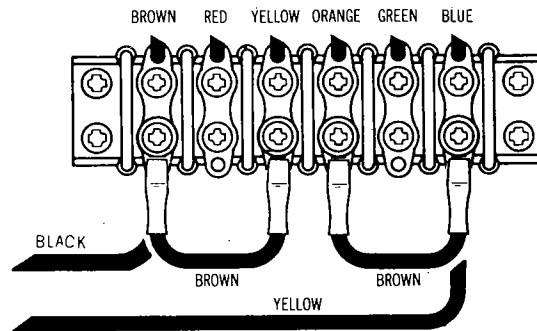

For 120V Operation

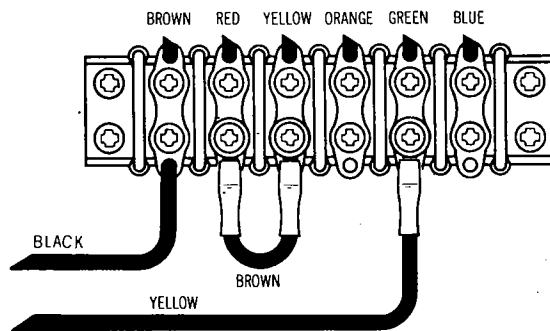

For 220V Operation

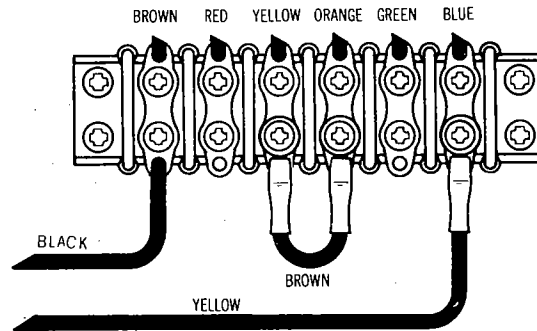

For 240V Operation

Figure 25. Voltage Conversion Chart

FTZ REGULATION

Instruction for the use in the range other than specified in FTZ codes

Achtung für die Leute, die in dem Gebiet wohnen, wo die FTZ-Bestimmungen vorherrschend sind.

Sollte das Gerät auch für Frequenzen ausserhalb des in den FTZ-Bestimmungen angegebenen Bereiches empfangsbereit sein, bitten wir, den Bereich durch Nachstellen des Kernes in der Oszillatorschleife (in der Abbildung mit "FTZ" gekennzeichnet) so zu korrigieren, dass er den Bestimmungen entspricht*